

**THE GOVERNMENT OF THE HONG KONG  
SPECIAL ADMINISTRATIVE REGION**

**Water Supplies Department**

**Planning Statement**

**S16 Planning Application for Proposed Minor Relaxation of Building Height  
Restriction for Re-provisioning of Tsuen Wan Water Treatment Works**

**March 2026**

**Applicant:**

Water Supplies Department  
New Works Branch  
Consultants Management Division  
Sha Tin Office - 6/F Sha Tin Government Offices  
1 Sheung Wo Che Road  
Sha Tin, NT

**Consultant:**

Binnies Hong Kong Limited  
43/F, AIA Kowloon Tower  
100 How Ming Street  
Kwun Tong  
Hong Kong

## CONTENTS

|                                                                                                                       |           |
|-----------------------------------------------------------------------------------------------------------------------|-----------|
| <b>EXECUTIVE SUMMARY</b> .....                                                                                        |           |
| <b>1 INTRODUCTION</b> .....                                                                                           | <b>1</b>  |
| 1.1 Objective of the Application .....                                                                                | 1         |
| 1.1 Project Background .....                                                                                          | 1         |
| 1.2 Overview of the Reprovision of Tsuen Wan Water Treatment Works .....                                              | 2         |
| 1.3 Structure of the Report .....                                                                                     | 2         |
| <b>2 PLANNING AND SITE CONTEXT</b> .....                                                                              | <b>3</b>  |
| 2.1 Statutory Plan .....                                                                                              | 3         |
| 2.2 Site Location and Existing Condition .....                                                                        | 3         |
| 2.3 Surrounding Land Uses .....                                                                                       | 3         |
| 2.4 Land Status .....                                                                                                 | 3         |
| <b>3 INDICATIVE DEVELOPMENT PROPOSAL</b> .....                                                                        | <b>4</b>  |
| 3.1 Proposed Sludge Treatment Plants of the TWWTW .....                                                               | 4         |
| <b>4 JUSTIFICATIONS</b> .....                                                                                         | <b>7</b>  |
| 4.1 Benefits to the Tsuen Wan and Kwai Chung Area from the In-situ Reprovision Work .....                             | 7         |
| 4.2 Necessary to Relax the Building Height to Accommodate Design Operation<br>Requirements and Site Constraints ..... | 7         |
| 4.3 No Insurmountable Technical Issues .....                                                                          | 9         |
| 4.4 Better Utilization of Scarce Land Resources .....                                                                 | 19        |
| <b>5 CONCLUSION</b> .....                                                                                             | <b>20</b> |
| 5.1 Conclusion and Recommendations .....                                                                              | 20        |

### List of Tables

|           |                                                                               |
|-----------|-------------------------------------------------------------------------------|
| Table 3-1 | Building Height of Proposed Facilities                                        |
| Table 3-2 | Proposed Facilities in the Application Site (Sludge Treatment Plants)         |
| Table 3-3 | Development Schedule for the STPs (Phase 1 and Phase 2)                       |
| Table 4-1 | Facilities in Proposed STPs                                                   |
| Table 4-2 | Magnitude of Visual Change                                                    |
| Table 4-3 | VPs for Visual Assessment                                                     |
| Table 4-4 | Summary of Significance of Visual Impact                                      |
| Table 4-5 | Annual and Summer Windrose Diagrams at Grids (070,054) & (071,054) at<br>200m |
| Table 4-6 | Summary of RAMS Data at 200m under Annual and Summer Conditions               |

### List of Figures (in CD ROM)

|          |                                             |
|----------|---------------------------------------------|
| Figure 1 | Master Layout Plan with Outline Zoning Plan |
| Figure 2 | Location Plan                               |
| Figure 3 | Master Layout Plan                          |

|           |                                                                            |
|-----------|----------------------------------------------------------------------------|
| Figure 4  | Site Access Plan                                                           |
| Figure 5  | Existing Site Photo Record Plan                                            |
| Figure 6  | Site Photo 1 – Existing Main Gate to TWWTW                                 |
| Figure 7  | Site Photo 2 – Existing Pumping House                                      |
| Figure 8  | Site Photo 3 – Existing Dangerous Good Containers and Pumping House        |
| Figure 9  | Site Photo 4 – Existing Access Road                                        |
| Figure 10 | Site Photo 5 – Existing On-site Chlorine Generation                        |
| Figure 11 | Site Photo 6 – Existing On-site Chlorine Generation                        |
| Figure 12 | Site Photo 7 – Existing Chlorination House (Not in Used)                   |
| Figure 13 | Site Photo 8 – Existing Chlorination House (Not in Used)                   |
| Figure 14 | Site Photo 9 – Existing Inlet Valve House and E&M Workshop                 |
| Figure 15 | Site Photo 10 – Existing Sludge Holding Tanks                              |
| Figure 16 | Site Photo 11 – Existing West Wing and Sludge Holding Tanks                |
| Figure 17 | Site Photo 12 – Existing Access Road and Washwater Recovery Tanks          |
| Figure 18 | Site Photo 13 – Existing East Wing                                         |
| Figure 19 | Site Photo 14 – Existing West Wing                                         |
| Figure 20 | Site Photo 15 – Junction of Shing Mun Road to TWWTW                        |
| Figure 21 | Site Photo 16 – Access Road to TWWTW                                       |
| Figure 22 | Rendering                                                                  |
| Figure 23 | General Arrangement – Sludge Treatment Plant (Phase 1) – Basement Floor    |
| Figure 24 | General Arrangement – Sludge Treatment Plant (Phase 1) – Ground Floor      |
| Figure 25 | General Arrangement – Sludge Treatment Plant (Phase 1) – First Floor       |
| Figure 26 | General Arrangement – Sludge Treatment Plant (Phase 1) – Second Floor      |
| Figure 27 | General Arrangement – Sludge Treatment Plant (Phase 1) – Roof Floor        |
| Figure 28 | General Arrangement – Sludge Treatment Plant (Phase 1) – Section           |
| Figure 29 | General Arrangement – Sludge Treatment Plant (Phase 2) – Basement Floor    |
| Figure 30 | General Arrangement – Sludge Treatment Plant (Phase 2) – Ground Floor      |
| Figure 31 | General Arrangement – Sludge Treatment Plant (Phase 2) – First Floor       |
| Figure 32 | General Arrangement – Sludge Treatment Plant (Phase 2) – Second Floor      |
| Figure 33 | General Arrangement – Sludge Treatment Plant (Phase 2) – Roof Floor        |
| Figure 34 | General Arrangement – Sludge Treatment Plant (Phase 2) – Section           |
| Figure 35 | Tree Fell Location Plan                                                    |
| Figure 36 | Assessment Area and Location of Viewing Points                             |
| Figure 37 | Viewing Point 1 – Shing Mun Valley Sports Grounds                          |
| Figure 38 | Viewing Point 2 – Junction at Sheung Kwai Chung Children Playground        |
| Figure 39 | Viewing Point 3 – Kwok Shui Road Park                                      |
| Figure 40 | Viewing Point 4 – Near the Entrance Gate at Shing Mun Valley Swimming Pool |
| Figure 41 | As-built Drawing of Tsuen Wan Water Treatment Works                        |

## **EXECUTIVE SUMMARY**

This planning application is prepared by Binnies Hong Kong Limited on behalf of the Applicant, Water Supplies Department (WSD) of the Government of the HKSAR, in support of an application to seek planning permission of the Town Planning Board (hereinafter call “the Board”) to relax the height restriction for the development of proposed sludge treatment plants (STPs) of Reprovisioning of Tsuen Wan Water Treatment Works in the Draft Tsuen Wan Outline Zoning Plan (OZP) No. S/TW/40.

The current land use zoning of the Application Site is “Government, Institution or Community (G/IC)”. On land designated “G/IC”, no new development, or addition, alteration and/or modification to or redevelopment of an existing building shall result in a total development and/or redevelopment in excess of the maximum building heights, in terms of number of storey(s) and/or metres above Principal Datum, as stipulated on the Plan, or the height of the existing building, whichever is the greater. It is also stated that based on the individual merits of a development or redevelopment proposal, minor relaxation of the plot ratio, site coverage and building height restrictions may be considered by the Town Planning Board (TPB) under Section 16 of the Town Planning Ordinance (TPO).

The proposed STPs consists of two buildings, each with 4 storeys and one level of basement. The gross floor area of proposed STPs will be approximately 4,136m<sup>2</sup>. Routine maintenance works, such as extraction of sludge to maintenance vehicle for disposal off site, will be carried out within the proposed STPs. The proposed Site could be accessed by maintenance vehicle via Shing Mun Road and a range of 3.5m to 4.5m width access road is provided within the proposed Site at the ground floor. The current maximum height in term of storey above ground of the proposed STPs is limited to 2 as specified in the Draft Tsuen Wan Outline Zoning Plan (OZP) No. S/TW/40.

The justifications of this application include: (i) Benefits to the Tsuen Wan and Kwai Chung Area from the In-situ Reprovisioning Work; (ii) Necessary to Relax the Building Height to Accommodate Design Operation Requirements and Site Constraints; (iii) No Insurmountable Technical Issues; (iv) Better Utilization of Scarce Land Resources.

The proposed structures forms part of the reprovisioned Tsuen Wan Water Treatment Works (TWWTW) for supplying freshwater to Tsuen Wan and Kwai Tsing areas. With the provision of the proposed STPs in TWWTW, less sewage would be generated from the TWWTW and discharged to public sewer. The Applicant therefore requests that the Board approve this application.

---

## 摘要

本規劃申請由賓尼斯工程顧問有限公司代表申請人——香港特別行政區政府水務署（下稱「申請人」）編製，旨在支持向城市規劃委員會（下稱「委員會」）提出申請以放寬《荃灣分區計劃大綱草圖》（圖則編號 S/TW/40）中有關原址重置荃灣濾水廠擬建污泥處理裝置的建築物高度限制。

申請地點的現行土地用途劃為「政府、機構或社區」。根據規劃圖則，在政府、機構或社區用地上，任何現有建築物的加建、改動及／或修改，或現有建築物的重建，不得引致整個發展及／或重建計劃的最高建築物高度(以樓層數目及／或以米為單位從主水平基準起計算)超過圖則上所指定的限制，或超過現有建築物的高度，兩者中以數目較大者為準。同時，圖則亦載明，委員會可根據《城市規劃條例》第 16 條，按個別發展或重建計劃的情況，考慮略為放寬地積比率、上蓋面積及建築物高度限制。

擬建的污泥處理裝置包括兩座建築物，總樓面面積約為 4,136 平方米，每座建築物設四層地面樓層及一層地庫。該污泥處理裝置內將設有日常維修工作，例如抽取污泥至維修車輛並運往濾水廠外處置。申請地點可經由城門道供維修車輛進入，並於地面層提供寬度介乎 3.5 米至 4.5 米的通道。根據《荃灣分區計劃大綱草圖》（圖則編號 S/TW/40），擬建污泥處理裝置的最高樓層限制為地面以上兩層。

本申請的理據包括：(i) 原址重置工程對荃灣及葵涌地區的效益；(ii) 因應設計運作需求及場地限制，須放寬建築物高度；(iii) 重置工程不存在不可克服的技術問題；(iv) 更有效地運用稀缺土地資源。

擬建污泥處理裝置屬原址重置荃灣濾水廠工程中的一部分，該濾水廠負責向荃灣及葵青地區供應食水。隨著污泥處理裝置的設置，濾水廠產生並排放至公共污水渠的污水量將會減少。因此，申請人謹此請求委員會批准本申請。

# 1 INTRODUCTION

## 1.1 Objective of the Application

1.1.1 This application is prepared by Binnies Hong Kong Limited (Binnies) on behalf of the Applicant, Water Supplies Department (WSD) of the Government of the HKSAR, to seek approval from the Town Planning Board (TPB) under Section 16 of the Town Planning Ordinance (TPO) for the proposed minor relaxation of the height restriction for the proposed Sludge Treatment Plants (STPs) under the reprovisioning works of Tsuen Wan Water Treatment Works (Proposed Development). To maintain continuous supply of freshwater, the operation of existing TWWTW shall be maintained during construction, the Proposed Development will be constructed in 2 phases. The proposed facilities under the Proposed Development in different phases are listed below.

- East Wing (Phase 1)
- West Wing (Phase 2)
- Administration Building (Phase 1)
- Hypochlorite Storage Tanks (Phase 1)
- Valve Inlet House (Phase 1)
- Chemical Storage (Phase 1 and Phase 2) and
- Sludge Treatment Plant (Phase 1 and Phase 2)

1.1.2 Most of the Proposed Development fulfills the current requirement as specified in the Draft Tsuen Wan Outline Zoning Plan No. S/TW/40 except the height restrictions of the proposed two blocks of 4-storey Sludge Treatment Plants as shown in the **Figure 1**. This report will illustrate the reasons for increasing the height restrictions.

## 1.1 Project Background

1.1.1 Tsuen Wan Water Treatment Works (TWWTW) was commissioned in 1957. It treats raw water from Shing Mun Reservoir (SMR), Tai Lam Chung Reservoir (TLCR) and raw water through Lower Shing Mun Raw Water Pumping Station (LSM RWPS). Currently, its supply zone mainly covers Kwai Chung and part of Tsuen Wan areas.

1.1.2 Considering the deteriorating condition due to aging of the existing TWWTW, to ensure the reliability of freshwater supply in Tsuen Wan and Kwai Tsing areas in future, the existing water treatment works are required to uprate its associated raw and freshwater facilities in phases to meet the current water treatment standards.

1.1.3 An upgrade and reprovision of the existing TWWTW is thus necessary to enhance the reliability of freshwater supply in Kwai Tsing and Tsuen Wan areas. The TWWTW is a major water treatment facility in New Territories West. Uninterrupted operation of the TWWTW is required throughout the implementation of the upgrading and reprovisioning, which is the need for the In-situ Reprovisioning of the TWWTW by phase (herein after referred as the “Project”).

1.1.4 On 19 June 2023, WSD appointed Binnies Hong Kong Limited (Binnies) to undertake an investigation study, design and construction supervision of the (hereinafter

referred as the “Assignment”) In-situ Reprovisioning of Tsuen Wan Water Treatment Works. The Project is currently under design stage.

## **1.2 Overview of the Reprovision of Tsuen Wan Water Treatment Works**

- 1.2.1 The overall reprovisioning works is to be completed in two phases; in the first phase, the East Wing of the existing TWWTW is to be redeveloped while the existing West Wing continues to provide freshwater to the network. The existing West Wing will be redeveloped in Phase 2 while the new East Wing will be in operation. The Application Site location plan and detailed phasing arrangement are enclosed in **Figure 2** and **Figure 3** respectively.
- 1.2.2 Phase 1 works are tentatively planned to complete not earlier than 2033 while Phase 2 works will be commenced after the completion of Phase 1 works subject to review.

## **1.3 Structure of the Report**

- 1.3.1 The Planning Study Report is structured as follows:

|           |                                                                                                                                                                        |
|-----------|------------------------------------------------------------------------------------------------------------------------------------------------------------------------|
| Section 1 | Introduction of the Project and this report;                                                                                                                           |
| Section 2 | Discussion on details of the Application Site (Sludge Treatment Plant), including its location, existing and surrounding land uses, land status, and planning context; |
| Section 3 | Discussion on the schematic development proposal;                                                                                                                      |
| Section 4 | Justifications in support of the planning application;                                                                                                                 |
| Section 5 | Conclusion.                                                                                                                                                            |

## 2 PLANNING AND SITE CONTEXT

### 2.1 Statutory Plan

2.1.1 The Application Site (Sludge Treatment Plants) falls within Draft Tsuen Wan Outline Zoning Plan No. S/TW/40 as shown in **Figure 1**. The Application Site falls within “Government, Institution or Community” (G/IC).

### 2.2 Site Location and Existing Condition

2.2.1 The Application Site (Sludge Treatment Plants) is located in the existing TWWTW – Sheung Kwai Chung, as shown in **Figure 2**. It sits at an approximate ground level of +105mPD on a hill between Castle Peak Road – Kwai Chung and Cheung Pei San Road. To the north and west of the Site lies the Shing Mun Valley Park. There are some village-type housing and high-rise residential buildings to the south and east of the site. Access to the Application Site is from the northeast via Shing Mun Road, leading of Wo Yi Hop Road. While exiting from the Application Site would be through Shing Mun Road and junction into Texaco Road North to the West of Site. Site access is shown in **Figure 4**.

2.2.2 TWWTW was built in 1957. The treatment works is divided into two streams, referred to as the East Wing and West Wing respectively. The existing Site condition is also shown with photos in **Figure 5** to **Figure 21**.

2.2.3 Currently, washwater from the existing TWWTW is handled by the existing sludge treatment facility (i.e. Washwater Recovery System) and the thickened sludge is discharged to the public sewer.

2.2.4 As shown in **Figure 22**, only central part of the East Wing and West Wing are 3 storeys while the remaining parts are 2 storeys. In the Proposed Development of TWWTW, the proposed new East Wing and West Wing have fully utilized its footprint to 4 storeys, which aligns with the height limitation specified in the Draft Tsuen Wan Outline Zoning Plan (OZP) No. S/TW/40.

### 2.3 Surrounding Land Uses

2.3.1 The Application Site (Sludge Treatment Plants) is located at government land while there are some village-type housing and high-rise residential buildings to the south and east of the Application Site (Sludge Treatment Plants).

### 2.4 Land Status

2.4.1 The Application Site (Sludge Treatment Plants) falls within government lands (GLA-TW-491), which its area is about 2,392m<sup>2</sup> as shown in **Figure 1**.

2.4.2 Currently, GLA-TW-491 is permanently assigned to WSD for water treatment works use. Therefore, neither resumption nor clearance or re-provisioning of private land is required.

### 3 INDICATIVE DEVELOPMENT PROPOSAL

#### 3.1 Proposed Sludge Treatment Plants of the TWWTW

- 3.1.1 The proposed STPs within the TWWTW would be part of the Proposed Development. The area of the Application Site is about 2,392m<sup>2</sup>. The overall Master Layout Plan (MLP) is shown in **Figure 3**.
- 3.1.2 Most of the reprovisioned structures fulfill the requirements as specified in the Outline Zoning Plan (OZP) except the two STPs. The two proposed STPs (4-storey buildings) which exceed the height restriction as specified in the approved OZP. Thus, the following sections will mainly focus on the details of the STPs for the height restriction.

**Table 3-1: Building Height of Proposed Facilities**

| Facilities                                                                                | Building Heights (storey, excluding basement) | Building Height Restrictions on OZP (storey, excluding basement) |
|-------------------------------------------------------------------------------------------|-----------------------------------------------|------------------------------------------------------------------|
| Proposed Sludge Treatment Plants of TWWTW                                                 |                                               |                                                                  |
| Sludge Treatment Building (Phase 1)                                                       | 4                                             | 2                                                                |
| Sludge Treatment Plant (Phase 2)                                                          | 4                                             | 2                                                                |
| Other proposed buildings of the Re-provisioning of TWWTW (comply with OZP BH restriction) |                                               |                                                                  |
| East Wing (Phase 1)                                                                       | 4                                             | 4                                                                |
| West Wing (Phase 2)                                                                       | 4                                             | 4                                                                |
| Administration Building (Phase 1)                                                         | 3                                             | 4                                                                |
| Inlet Valve House (Phase 1)                                                               | 1                                             | 2                                                                |
| Chemical Storage (Phase 1)                                                                | 1                                             | 2                                                                |
| Chemical Storage (Phase 2)                                                                | 2                                             | 2                                                                |
| Hypochlorite Storage Tanks                                                                | 1                                             | 2                                                                |

- 3.1.3 As shown in **Table 3-2**, the following facilities of proposed STPs would be constructed in phase 1 and phase 2 respectively. The underground structure could be accessed by staircase within the above ground structure. The sizes and internal layout of the Proposed Development, as well as the above ground structures, would be subject to review at the detailed design stage. The layout arrangements and sectional view of STPs are shown in **Figure 23** to **Figure 34**.

**Table 3-2: Proposed Facilities in the Application Site**

|                               | Facilities Above Ground Storey                                                                                                              | Facilities Below Ground Storey         |
|-------------------------------|---------------------------------------------------------------------------------------------------------------------------------------------|----------------------------------------|
| <b>Proposed STP (Phase 1)</b> | Motor Control Centre Hall, Thickened Sludge Holding Tank, Filter Press and Pump Hall, Transformer Room, Switch Room, Thickener Storage Tank | Polymer Room and Sludge Balancing Tank |

|                               | Facilities Above Ground Storey                                                                                                              | Facilities Below Ground Storey         |
|-------------------------------|---------------------------------------------------------------------------------------------------------------------------------------------|----------------------------------------|
| <b>Proposed STP (Phase 2)</b> | Motor Control Centre Hall, Thickened Sludge Holding Tank, Filter Press and Pump Hall, Transformer Room, Switch Room, Thickener Storage Tank | Polymer Room and Sludge Balancing Tank |

3.1.4 A 3.5 m to 4.5 m width loading/unloading area is provided within the proposed STPs at the ground floor. Routine maintenance works, such as extraction of sludge to maintenance vehicle for disposal off site, will be carried out within the proposed STPs. The proposed STPs could be accessed by maintenance vehicle via Shing Mun Road. The maximum height of storeys above ground of the STPs is 4 storeys and the details of storey arrangement of the proposed STPs is shown in **Table 3-3**.

**Table 3-3: Development Schedule for the STPs (Phase 1 and Phase 2)**

| Facilities                                                                 | Building Height (top roof level), mPD | Floor Area (m <sup>2</sup> ) | Total GFA (m <sup>2</sup> ) | No. of Storey (above ground) | Basement (below ground) |
|----------------------------------------------------------------------------|---------------------------------------|------------------------------|-----------------------------|------------------------------|-------------------------|
| <b>Proposed STP (Phase 1)</b>                                              | 138.10                                | 435                          | 2,076                       | 4                            | 1                       |
| <b>Proposed STP (Phase 2)</b>                                              | 138.10                                | 432                          | 2,060                       | 4                            | 1                       |
| <b>Total Floor Area of STPs (m<sup>2</sup>)</b>                            |                                       |                              | 867                         |                              |                         |
| <b>The Application Site (Sludge Treatment Plants) Area (m<sup>2</sup>)</b> |                                       |                              | About 2,392                 |                              |                         |

3.1.5 The proposed STPs (Phase 1 and Phase 2) will have a founding depth of 8m, similar to that of the proposed East Wing and West Wing. Since the construction of the proposed STPs are founded close to the existing slope, and in close proximity to the existing operating facilities, pile foundation will be adopted to minimise the impact to the existing slopes and operating facilities.

3.1.6 Compared to the existing TWWTW, the proposed STPs would include sludge thickening and dewatering facilities which will further enhance the water recovery rate (i.e. reduce the volume of sewage to be discharged to public sewer). By considering the hydraulic condition, the height of the proposed STPs is required to have 4 storeys to accommodate sludge thickening tanks, filter press and associated chemical dosing system.

3.1.7 Currently, there are 2 affected trees (undesirable species *Leucaena leucocephala*), namely T380 and T381 are located within the Application Site as shown in **Figure 35**. As per DEVB TC(W) No. 4/2020, trees of undesirable species shall be removed as soon as possible. An **Updated Tree Preservation and Removal Proposal** will be submitted to Tree Works Vetting Panel (TWVP) of Development Bureau for agreement.

- 3.1.8 Landscape features are designed to achieve maximum convenience and efficiency for the usage of water treatment works areas with the adoption of tree planting, ground cover and shrubs to minimise visual impact. Photomontages of the overall Proposed Development is provided in **Figure 36 to 40**.
- 3.1.9 The Proposed Development at TWWTW associated with the access road abuts Shing Mun Road (as shown in **Figure 4**). Site ingress and egress will be provided through the entrance gate at Shing Mun Road. The entrance gate is required to guard against illegal entrance to the Application Site (Sludge Treatment Plants).

## 4 JUSTIFICATIONS

### 4.1 Benefits to the Tsuen Wan and Kwai Chung Area from the In-situ Reprovision Work

4.1.1 As mentioned in **Section 3.1.6**, the proposed STPs is to enhance the water recovery rate to form sludge cake with dry solid content  $\geq 30\%$  (i.e. less sewage would be generated and discharge to the public sewer). The existing water recovery rate is about 98% while the reprovisioned TWWTW will enhance the water recovery rate to 99.5%. Upgrading treatment processes and infrastructure will ensure operational resilience and support long-term sustainability of the regional water supply network.

### 4.2 Necessary to Relax the Building Height to Accommodate Design Operation Requirements and Site Constraints

4.2.1 The existing two-storey height limit restricts the available floor area, which leads to insufficient floor area to accommodate the full range of treatment facilities, equipment, and support spaces required for the sludge treatment plant. To meet operational needs, additional storeys are thus necessary.

4.2.2 Sludge treatment at water treatment works in Hong Kong is an essential process to manage sludge generated during water purification. The reasons to have sludge treatment are listed below.

(1) Volume reduction and Cost Efficiency

Sludge from water treatment processes has a very high water content which making it bulky and difficult to handle. Gravity thickeners and filter presses are adopted to remove excessive water, pressing the sludge into dry cakes. Dry sludge cakes (solid content  $\geq 30\%$ ) would have significant small volume which lowers the cost of transporting waste to disposal sites and minimizes the use of limited landfill space.

(2) Legal and Environmental Compliance

Hong Kong has strict regulations regarding waste disposal to prevent secondary pollution. The Environmental Protection Department (EPD) requires that sludge must reach a minimum of 30% dryness before it can be accepted at landfills since early 1993.

4.2.3 The sludge treatment of the existing TWWTW is simple sedimentation process which is still bulky with high water content. The simple sedimentation process only requires a tank for gravity sedimentation with less equipment as shown **Figure 4.1**. Therefore, 1 storey structure would be good enough. As mentioned in **Clause 4.2.2**, additional equipment such as gravity thickener, filter presses and associated pumps & power cabinets would be required to generate sludge cakes with solid contents  $\geq 30\%$  for landfill dumping. This process fosters the goal of zero net discharge to the public sewerage system. Therefore, additional storeys are required to accommodate these equipments within the Application Site (Sludge Treatment Plants).

4.2.4 There are 4 storeys of the proposed STPs above ground. Facilities accommodate in each storey with the justification of each storey height is shown in **Table 4-1**. Similar

arrangements are commonly adopted in other water treatment works such as Ngai Tam Mei Water Treatment Works.

**Table 4-1: Facilities in Proposed STPs**

|                             | <b>Facilities</b>                           | <b>Height</b> | <b>Justification on Height</b>                                                                                                                                                                                                                                                                                                                                                                                                                                                                                                                                                                                                                                                                                                                                                                                                                                                                                                                                                                                                                                                                                                                                                                                                                                                                                                                                               |
|-----------------------------|---------------------------------------------|---------------|------------------------------------------------------------------------------------------------------------------------------------------------------------------------------------------------------------------------------------------------------------------------------------------------------------------------------------------------------------------------------------------------------------------------------------------------------------------------------------------------------------------------------------------------------------------------------------------------------------------------------------------------------------------------------------------------------------------------------------------------------------------------------------------------------------------------------------------------------------------------------------------------------------------------------------------------------------------------------------------------------------------------------------------------------------------------------------------------------------------------------------------------------------------------------------------------------------------------------------------------------------------------------------------------------------------------------------------------------------------------------|
| <b>Basement</b>             | Polymer Room and Sludge Balancing Tank      | 8m            | -                                                                                                                                                                                                                                                                                                                                                                                                                                                                                                                                                                                                                                                                                                                                                                                                                                                                                                                                                                                                                                                                                                                                                                                                                                                                                                                                                                            |
| <b>Gloor Floor</b>          | Transformer Room, Switch Room, Polymer Room | 7m            | The height of 7m is provided to allow the sludge collection vehicles for loading and unloading works at Ground floor (i.e. including mobile arm taking up & down of the skip)                                                                                                                                                                                                                                                                                                                                                                                                                                                                                                                                                                                                                                                                                                                                                                                                                                                                                                                                                                                                                                                                                                                                                                                                |
| <b>1<sup>st</sup> Floor</b> | Filter Press Hall                           | 13m           | <p>The height of filter press is about 5m with additional 2.5m head room including moving crane installation to facilitate the future maintenance works. About 5.5m is reserved for sludge conveyor under the filter press to transfer the sludge to skip at Ground floor.</p> <p>The requirement for a 13-metre headroom on the 1/F arises from the combined operational and maintenance needs of filter press and associated equipment. The overhead crane is the primary driver, as it must safely lift and manoeuvre heavy components such as filter press plates and conveyor assemblies. This requires significant hook travel, clearance above the highest lifted load, and structural depth for crane beams, resulting in a vertical demand of 13 meters (5m+2.5m+5.5m) on its own.</p> <p>The filter press system further contributes to the height requirement. Large presses need additional space above the machine for plate opening sequences, cake discharge, and maintenance access to the hydraulic system. Below the press, a free fall zone for sludge cake and the installation of multi-level conveyors add further vertical layering.</p> <p>When combined with space for ducting, pipework, and maintenance walkways, these elements collectively justify the need for an overall 13-metre headroom to ensure safe and efficient plant operation.</p> |

|                             | Facilities                                       | Height | Justification on Height                                                                                                          |
|-----------------------------|--------------------------------------------------|--------|----------------------------------------------------------------------------------------------------------------------------------|
| <b>2<sup>nd</sup> Floor</b> | MCC Hall,<br>Thickened<br>Sludge Holding<br>Tank | 6m     | The height of holding tank is about 6m to cater for the storage of daily flow of thickened sludge (i.e. 308 m <sup>3</sup> /day) |
| <b>Roof</b>                 | Sludge<br>Thickener                              | 7m     | The height of 7m to cater for the daily flow of sludge thickener (i.e. ~1,005 m <sup>3</sup> /day)                               |

4.2.5 The Application Site (Sludge Treatment Plants) designated for the proposed STPs has a limited footprint, which restricts horizontal expansion. An access road located immediately adjacent to the STP (Phase 1) imposes a physical constraint that prevents the consolidation of the Phase 1 and Phase 2 STPs into a single building. To optimize land use and accommodate operational requirements, the proposed STPs is divided into two buildings across two phases.

4.2.6 The proposed East Wing and West Wing will fully utilize the 4-storey restriction zone, thereby eliminating the option of accommodating the proposed STPs within the new East Wing and new West Wing.

4.2.7 Due to the sloping topography of the Application Site, the inclusion of the northern portion of the Sludge Treatment Plant (Phase 2) within the site boundary is to provide flexibility for the future construction of Phase 2 Works, which preserves the potential of adjustment of the footprint of the Sludge Treatment Plant (Phase 2) subject to future site conditions and construction sequence proposed by the contractor. In addition, the site boundary includes the existing fencing and filter beds for comprehensiveness to replace the existing filter beds.

### 4.3 No Insurmountable Technical Issues

#### 4.3.1 Traffic Impact Review

4.3.1.1 Traffic impact assessment has been carried out to review potential traffic impacts which might arise from the latest development parameters of the Proposed Development.

4.3.1.2 As the existing use of the Application Site aligns with the proposed use, it is anticipated the Proposed Development would not induce insurmountable traffic impact onto adjacent road network. The Proposed Development is acceptable from traffic point of view.

4.3.1.3 The Application Site (Sludge Treatment Plants) is part of the development site area while it is expected that only a few vehicles (about 2 vehicles/day) will be induced due to the operation of STPs. Therefore, there would be no specific traffic impact.

#### 4.3.2 Preliminary Environmental Review

4.3.2.1 The Project is not a designated project under the Environmental Impact Assessment Ordinance (Cap 499).

4.3.2.2 There is insignificant odour impact arising from the Application Site. The sludge from drinking water treatment has low organic content, providing minimal substrates for

microbial decomposition, which is a primary source of odors. Additionally, lime dosing is implemented in the sludge treatment plant to raise the pH of the sludge, creating an alkaline environment that inhibits odor-producing anaerobic bacteria. The lime-treated sludge is chemically stable, minimizing decomposition and odor generation during storage.

- 4.3.2.3 A Preliminary Environmental Review (PER) has been conducted and concluded that the proposed works will not cause any long-term adverse environmental impacts. The PER has recommended suitable measures to mitigate short-term environmental impacts during construction.
- 4.3.2.4 Most of the noisy equipment in the proposed Water Treatment Works are fully enclosed underground or enclosed by concrete structure. No unacceptable operational noise impact is anticipated.
- 4.3.2.5 The operation of plants and the handling of chemicals at the reprovisioned TWWTW (including proposed Sludge Treatment Plants) will be conducted in a controlled environment designed to prevent emissions or leaks. This includes the use of enclosed treatment units to contain chemical processes, filtered ventilation systems to remove potential airborne pollutants, and monitoring systems to detect and address any irregularities. Additionally, no chlorine gas or ozone will be stored on site. Consequently, no adverse air quality impact is anticipated during the operation of the Project.
- 4.3.2.6 The use of powered mechanical equipment during the construction phase of the Project is expected to create noise impact to the nearby NSRs. Assessment indicates that the construction noise level at the representative NSRs can be complied with the required noise criteria in the Environmental Impact Assessment Ordinance - Technical Memorandum by use of quiet construction equipment, erecting noise barriers / enclosures and implementing good site practices.
- 4.3.2.7 Potential water quality impact associated with land-based construction works for the Project would be generated from site run-off, wastewater from construction activities, and sewage from workforce. With the implementation of the recommended mitigation measures, no adverse water quality impacts would be expected during the construction phase of the Project. Regular site inspection would be conducted to ensure the recommended mitigation measures are properly implemented.
- 4.3.2.8 During the operation phase of the Project, major sources of water quality impact would be washwater effluent, overflow, emergency discharge, and chemical spillage from treatment works components. Proper mitigation measures will implemented to fulfill the requirements as specified in discharge license avoiding discharge of washwater effluent, overflow, emergency discharge, and chemical spillage into the nearby water environment and hence no adverse water quality would be expected.
- 4.3.2.9 Waste types generated by the construction activities are considered to include inert and non-inert C&D materials, general refuse and chemical waste. Provided that these identified wastes would be handled, transported and disposed of using the recommended methods and that good site practices would be strictly followed, adverse environmental impacts are not expected.

---

4.3.2.10 A review of the past and present land use of the Project Site was conducted. Based on the desktop appraisal and site walkover, potential land contamination issues are not anticipated from the construction works within TWWTW.

#### 4.3.3 Landscape and Visual Appraisal

4.3.3.1 As mentioned in **Section 4.3.2**, the Proposed Development will be confined to developed and localized areas, with minimal disruption to the surrounding environment and nearby residents. The rendering is presented in **Figure 22**.

4.3.3.2 Upon completion, the works area will be properly cleaned and reinstated. With the implementation of good site practices, no adverse landscape or visual impacts are anticipated during the operation phase. As mentioned in **Section 3.1.8**, only two existing trees will be affected which will fall due to the construction works of the proposed STPs. An **Updated Tree Preservation and Removal Proposal** will be submitted to Tree Works Vetting Panel (TWVP) of Development Bureau for agreement.

##### Visual Appraisal

4.3.3.3 An visual appraisal according to TPB PG-No. 41A has been carried out to evaluate the visual impacts of increasing the building height restriction (BHR) to 4 storeys as compared with existing condition for the two blocks of proposed sludge treatment plants. There are no significant visual impacts to the nearby environments.

##### Identified Viewpoints (VPs)

4.3.3.4 The following 4 VPs, as listed in **Table 4-2** and shown in **Figure 36 to 40**, are selected to assess the potential visual impacts. Selected VPs cover public views from easily accessible and popular area from north, northeast and southeast of the Application Site (Sludge Treatment Plants)

- i. VP1 – Shing Mun Valley Sports Grounds: VP1 is a public space containing a standard soccer pitch, 10 runways with 400m, audience stands. It is located at the north of the Application Site (Sludge Treatment Plants) where the topography is 43.2mPD and approximately 250m away. The viewers will mainly be the users of the Sports Grounds for active recreational activities, who will be potentially affected by the proposed STPs visually.
- ii. VP2 – Junction at Sheung Kwai Chung Children Playground: VP2 is at Sheung Kwai Chung Road, which is located at the northeast of the Application Site (Sludge Treatment Plants) with a topography of 56.6mPD and a distance of approx. 560m. The viewers will mainly be pedestrians passing through the junction and users of the playground. This VP is in close proximity to Sheung Kwai Chung.
- iii. VP3 – Kwok Shui Road Park near Tai Wo Hau Station: VP3 is located at the southwestern of Application Site (Sludge Treatment Plants) where the topography is 9.3mPD and approximately 420m away. This VP is selected

to represent the view of users of Kwok Shui Road Park and pedestrians of Kwok Shui Road.

- iv. VP4 – Near the Entrance Gate at Shing Mun Valley Swimming Pool: VP4 is located at the entrance gate of Shing Mun Valley Swimming Pool where the topography is 20 mPD and approximately 470m away. The viewers of this VP will be mainly users of Shing Mun Valley Swimming Pool and pedestrians of Shing Mun Road.

4.3.3.5 Although there is “SLIGHT” impact in VP1 and VP4 as shown in **Table 4-4**, all edges of the façade feature rounded corners, creating a smooth flow and enhancing the overall sense of movement (see Photomontages in **Figure 36 to 40**).

4.3.3.6 The Magnitude of Change and Sensitivity of VPs/Viewers is presented in **Table 4-2**, while the sensitivity of VPs is summarized in **Table 4-3**.

Table 4-2: Magnitude of Visual Change

| VP Location                                          | Source of Visual Impact                 | Visual Composition, Visual Obstruction and Visual Change                                                                                                                                                                                                                                                                                                                                                                                                                  | Magnitude of Change |
|------------------------------------------------------|-----------------------------------------|---------------------------------------------------------------------------------------------------------------------------------------------------------------------------------------------------------------------------------------------------------------------------------------------------------------------------------------------------------------------------------------------------------------------------------------------------------------------------|---------------------|
| 1. Shing Mun Valley Sports Grounds                   | Aboveground Structures of Proposed STPs | <p>Before the Proposed Development, the value of this view is primarily attached to the open sky view.</p> <p>The Proposed Development would maintain the foreground and midground. It will only alter the character of the background of this view which results in slight blockage to the mountain ridgeline and the sky view.</p> <p>Degree of visibility: Partial</p> <p>No designated landmark or heritage feature is visually lost</p> <p>Viewing distance: Far</p> | Slight              |
| 2. Junction at Sheung Kwai Chung Children Playground | Aboveground Structures of Proposed STPs | <p>Before the Proposed Development , the value of this view is primarily attached to the open sky view and vegetated hills.</p> <p>The Proposed Development will not obstruct the sky view and the vegetated hills.</p> <p>No designated landmark or heritage feature is visually lost.</p> <p>Viewing distance: Far</p>                                                                                                                                                  | Negligible          |

| VP Location                                                 | Source of Visual Impact                 | Visual Composition, Visual Obstruction and Visual Change                                                                                                                                                                                                                                                                                                                                                                                                                                       | Magnitude of Change |
|-------------------------------------------------------------|-----------------------------------------|------------------------------------------------------------------------------------------------------------------------------------------------------------------------------------------------------------------------------------------------------------------------------------------------------------------------------------------------------------------------------------------------------------------------------------------------------------------------------------------------|---------------------|
| 3. Kwok Shui Road Park                                      | Aboveground Structures of Proposed STPs | <p>Before the Proposed Development, the value of this view is primarily attached to the open sky view.</p> <p>The Proposed Development will not obstruct the sky view.</p> <p>No designated landmark or heritage feature is visually lost.</p> <p>Viewing distance: Far</p>                                                                                                                                                                                                                    | Negligible          |
| 4. Near the Entrance Gate at Shing Mun Valley Swimming Pool | Aboveground Structures of Proposed STPs | <p>Before the Proposed Development , the value of this view is primarily attached to the sky view and vegetated hill sides.</p> <p>The Proposed Development would maintain the foreground and midground. It will only alter the character of the background of this view which results in slight blockage to the mountain ridgeline and the sky view.</p> <p>Degree of visibility: Partial</p> <p>No designated landmark or heritage feature is visually lost</p> <p>Viewing distance: Far</p> | Slight              |

Table 4-3: VPs for Visual Assessment

| VP Location                                                    | Distance/<br>Direction<br>(Approx.) | Height in mPD<br>(Approx.) | Viewers                                             | Nature of VP                        | Popularity by<br>Public | Visual<br>Sensitivity <sup>[1]</sup> |
|----------------------------------------------------------------|-------------------------------------|----------------------------|-----------------------------------------------------|-------------------------------------|-------------------------|--------------------------------------|
| Shing Mun Valley Sports<br>Grounds                             | 250m/ North                         | +43.2                      | Athletes/<br>People doing<br>exercises/Audi<br>ence | Active<br>Recreation                | Frequent                | Low                                  |
| Junction at Sheung Kwai<br>Chung Children Playground           | 560m/<br>Northeastern               | +56.6                      | Pedestrians,<br>Playground<br>Users                 | Transient,<br>Passive<br>Recreation | Occasional              | Low                                  |
| Kwok Shui Road Park                                            | 420m/<br>Southwester<br>n           | +9.3                       | Pedestrians                                         | Transient                           | Frequent                | Low                                  |
| Near the Entrance Gate at<br>Shing Mun Valley Swimming<br>Pool | 470m/<br>Southwester<br>n           | +20                        | Pedestrians                                         | Transient                           | Frequent                | Low                                  |

Note [1]: Visual sensitivity is determined by the activity/type of the viewers and the public perception of value attached to the views being assessed. For example, people engaging in active recreational activities such as playing basketball or football at the VP are less sensitive to visual change than passive recreational activities.

4.3.3.7 The visual assessment results of each VP are summarized in **Table 4-4**. Therefore, the visual impact arising from the Site (Phase 1 & 2) to the surrounding is considered insignificant.

**Table 4-4: Summary of Significance of Visual Impact**

| VP ID | Magnitude of Change | Sensitivity of VPs/Viewer | Impact Significance |
|-------|---------------------|---------------------------|---------------------|
| 1     | Slight              | Low                       | Slight              |
| 2     | Negligible          | Low                       | Negligible          |
| 3     | Negligible          | Low                       | Negligible          |
| 4     | Slight              | Low                       | Slight              |

#### 4.3.4 Other Design Measures to Minimise Visual Impacts

4.3.4.1 The façade design enables the water treatment facilities to integrate harmoniously with the surrounding environment through its restrained material palette, softened geometry, and modulation of scale. The light grey painted aluminum fins and concrete external walls adopt neutral tones that complement the natural greenery and sky backdrop, allowing the buildings to recede visually rather than dominate the landscape. The vertical fins, arranged in varying rhythms, subtly echo the verticality of nearby trees, creating a visual dialogue with the surrounding vegetation. There are no adverse visual impacts.

4.3.4.2 The incorporation of rounded corners and curved façade elements reduces the perceived bulk of the building mass, softening its institutional character and enhancing visual permeability. These flowing forms respond sensitively to the natural contours of the site, creating a smoother transition between the built structure and the landscape. Furthermore, the integration of planter bands at terrace levels introduces greenery onto the façade, reinforcing the connection with the adjacent natural environment and contributing to a layered, landscape-responsive architectural expression.

4.3.4.3 Overall, the combination of muted colours, textured vertical articulation, softened edges, and integrated planting ensures that the façade achieves visual compatibility with its context while maintaining a contemporary and refined architectural identity.

#### 4.3.5 Air Ventilation Appraisal

4.3.5.1 According to an Expert Evaluation on Advisory Report for an Instructed Project for Tsuen Wan by PlanD in 2012, the Application Site lies within annual and summer air paths for the Sheung Kwai Chung and Shing Mun Valley areas. It acts as the gateway to the breeze for downhill wind and easterlies. The evaluation recommended maintaining the existing green belt to preserve and improve air ventilation for the wider Tsuen Wan area.

4.3.5.2 Site wind availability is analyzed using Regional Atmospheric Modelling System (RAMS) data and experimental wind studies adopted in AVR/G/65. The latest two RAMS data of the grid (071,054) & (070,054) are extracted from the Site Wind Availability Data of Planning Department’s website are used for the assessment.

4.3.5.3 **Table 4-5** shows the relevant windrose diagrams representing the frequency and wind speed distribution at 200m height of the district concerned during the annual condition and summer condition (i.e. June – August) respectively. The wind frequency data under the annual and summer conditions at 200m are shown in **Table 4-6**.

**Table 4-5: Annual and Summer Windrose Diagrams at Grids (070,054) & (071,054) at 200 m**

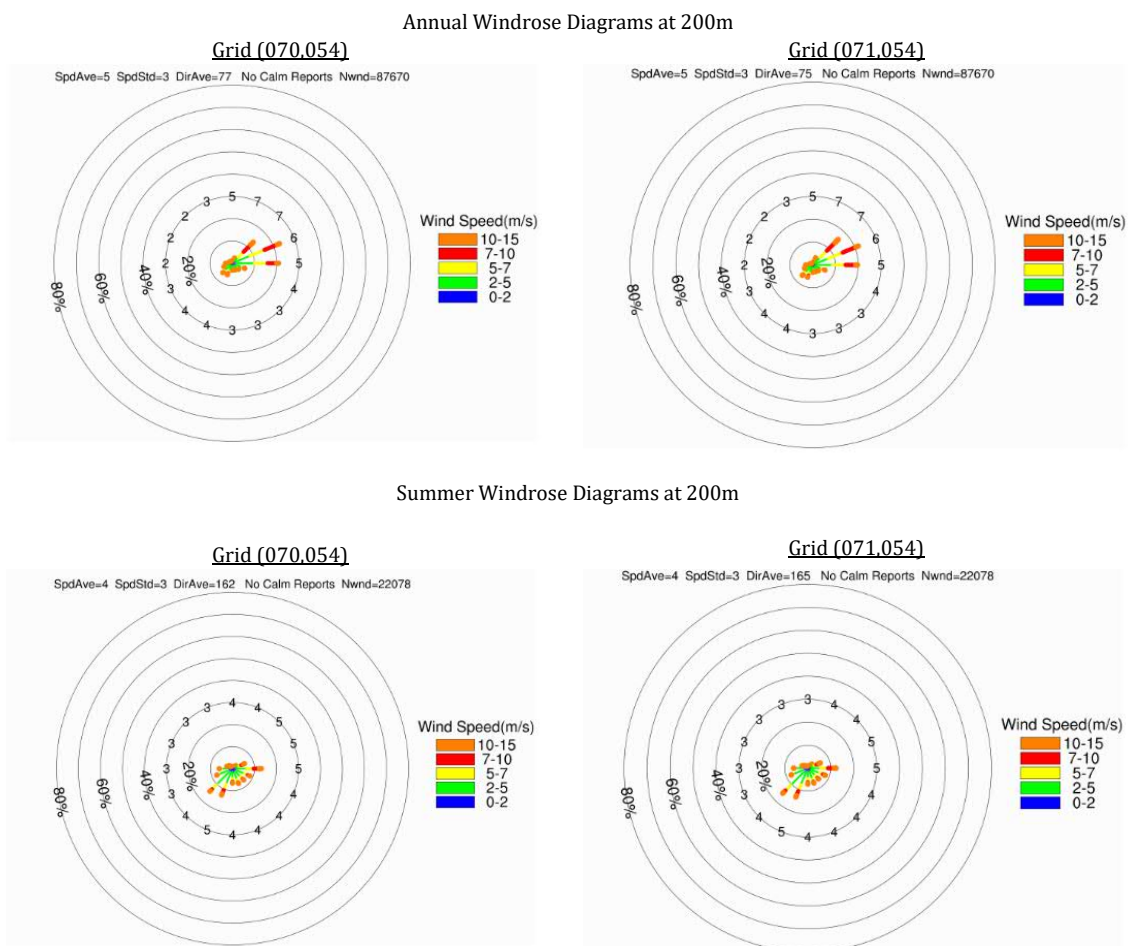

4.3.5.4 According to the two set of RAMS wind data, the annual prevailing winds are coming from NE, ENE and E, whereas the summer prevailing winds are coming from E, SSW and SW directions.

**Table 4-6: Summary of RAMS Data at 200m under Annual and Summer Conditions**

| Wind Direction | Wind Rose (071,054)              |                                  | Wind Rose (070,054)              |                                  |
|----------------|----------------------------------|----------------------------------|----------------------------------|----------------------------------|
|                | Probability for Annual Condition | Probability for Summer Condition | Probability for Annual Condition | Probability for Summer Condition |
| <b>N</b>       | 1.0%                             | 0.7%                             | 1.3%                             | 0.7%                             |
| <b>NNE</b>     | 3.6%                             | 1.1%                             | 2.7%                             | 0.9%                             |
| <b>NE</b>      | 16.0%*                           | 2.5%                             | 13.5%*                           | 2.1%                             |
| <b>ENE</b>     | 21.7%*                           | 6.0%                             | 23.1%*                           | 6.1%                             |
| <b>E</b>       | 19.6%*                           | 12.4%*                           | 20.8%*                           | 13.2%*                           |
| <b>ESE</b>     | 5.9%                             | 8.2%                             | 6.1%                             | 8.6%                             |
| <b>SE</b>      | 3.6%                             | 6.7%                             | 3.9%                             | 7.2%                             |
| <b>SSE</b>     | 3.2%                             | 7.1%                             | 3.3%                             | 7.3%                             |
| <b>S</b>       | 3.2%                             | 6.9%                             | 3.1%                             | 6.6%                             |
| <b>SSW</b>     | 5.8%                             | 13.6%*                           | 5.6%                             | 13.0%*                           |
| <b>SW</b>      | 6.4%                             | 15.5%*                           | 6.0%                             | 14.6%*                           |
| <b>WSW</b>     | 3.9%                             | 7.9%                             | 4.0%                             | 7.8%                             |
| <b>W</b>       | 3.1%                             | 6.2%                             | 3.0%                             | 6.1%                             |
| <b>WNW</b>     | 1.4%                             | 2.7%                             | 1.4%                             | 2.8%                             |
| <b>NW</b>      | 0.9%                             | 1.6%                             | 1.1%                             | 2.0%                             |
| <b>NNW</b>     | 0.7%                             | 0.9%                             | 0.9%                             | 1.1%                             |

Note:

- (a) \* Denotes: Selected prevailing wind directions for evaluation.
- (b) RAMS = Regional Atmospheric Modelling System

- 4.3.5.5 According to the Expert Evaluation and Advisory Report for an Instructed Project for Tsuen Wan Area, the site is also subject to annual prevailing wind from the north. Hence, the annual prevailing winds are mainly from North (N), Northeast (NE), East (E), East-Northeast (ENE), while the summer prevailing winds are mainly from East (E), South-Southwest (SSW), Southwest (SW).
- 4.3.5.6 The Application Site sits on a 105mPD hill. To the immediate surrounding of the Application Site are structures of the reprovisioned TWWTW as permitted on the OZP; surrounding high-rise and low-rise developments are at least 100–200 meters away, with open areas and hills influencing wind flow. No significant topographical barriers exist for summer wind directions.
- 4.3.5.7 While the development of the proposed STPs of four-storey high may limit the wind availability at the surrounding area as compared with the existing condition with minor structures of one storey in height, it is likely to cause insignificant and localized obstruction of prevailing winds.
- 4.3.5.8 In addition, the nearest surrounding sensitive area is located at more than 100 m away from the Application Site (Sludge Treatment Plants). It is anticipated that there will be insignificant impact to the wind environment in the surrounding area associated with the Proposed Development.

4.3.5.9 Considering the scale of the Proposed Development and the distance to sensitive receivers, no significant impact on air ventilation will be anticipated from the proposed increase in building height.

#### 4.3.6 Drainage and Sewerage

4.3.6.1 A drainage system in line with the Proposed Development within the development site area would be designed during the detailed design stage and the proposed drain would be connected to the nearby drainage system.

4.3.6.2 After the review of Drainage Impact Assessment and Sewerage Impact Assessment, no significant impact on both drainage and sewerage will be anticipated.

#### 4.3.7 Geotechnical Impact Assessment

4.3.7.1 Feature No. 7SW-C/F90 is located West to the Sludge Treatment Facilities (Phase 1). It is a 40m long, maximum 5m high with an average angle of 32 degrees. The location of this feature exposes it to risks from water-carrying services, fill replacement by no-fines concrete is proposed for the upgrading of the slope.

4.3.7.2 An unregistered fill slope is located to the North of the Sludge Treatment Facilities (Phase 2). The slope has a maximum height of about 5m and a gradient of about 35 degrees. Failure of the slope may impact on the Sludge Treatment Facilities. To facilitate the proposed new development, the Slope will be upgraded with a retaining along the interface line between the new access road and the slope itself.

4.3.7.3 The assessment of the slopes has been approved by CEDD/GEO through the finalised Geotechnical Assessment Report.

#### 4.3.8 Minimum Disruption to Existing/Planned Uses

4.3.8.1 The Application Site (Sludge Treatment Plants) falls within Government land and no insurmountable constraint on land ownership is envisaged for the proposed Treatment Plant. The Application Site is distant from village house area. This would avoid any impact to the adjoining existing and potential village houses development.

### **4.4 Better Utilization of Scarce Land Resources**

4.4.1 The Application Site (Sludge Treatment Plants) is located at a government land away from village area that does not reclaim private or occupied land. The proposed planning facilitates better utilization of scarce land resources.

## **5 CONCLUSION**

### **5.1 Conclusion and Recommendations**

- 5.1.1 The proposed increase of building height involves increasing the maximum building height of the proposed STPs (Phase 1 and Phase 2) from current limit of two storeys to four storeys.
- 5.1.2 It has been demonstrated in this Planning Statement that the proposed increase in building height restrictions will facilitate reducing sewage discharge from the reprovisioned TWWTW.
- 5.1.3 As demonstrated in the justifications, it is anticipated that the Proposed Development of the Application Site will not induce adverse landscape, visual, traffic, air ventilation, environmental, sewerage and other engineering impacts to the area.
- 5.1.4 In light of the planning merits and justifications put forward in this Planning Statement, we sincerely seek for the favourable consideration from the TPB to give its support to this S16 Application.

**END OF TEXT**

**Figures (in CD ROM)**

**LEGENDS**

- VILLAGE
- G/IC GOVERNMENT, INSTITUTION OR COMMUNITY
- O OPEN SPACE
- R RESIDENTIAL
- REINSTATED SLOPE
- OXYGEN TANK (OUTDOOR AREA)
- CURRENT OZP BOUNDARY
- APPLICATION SITE BOUNDARY
- OVERALL DEVELOPMENT SITE BOUNDARY FOR REPROVISION OF TSUEN WAN WATER TREATMENT WORKS
- GLA BOUNDARY
- PAVED CONCRETE ROAD

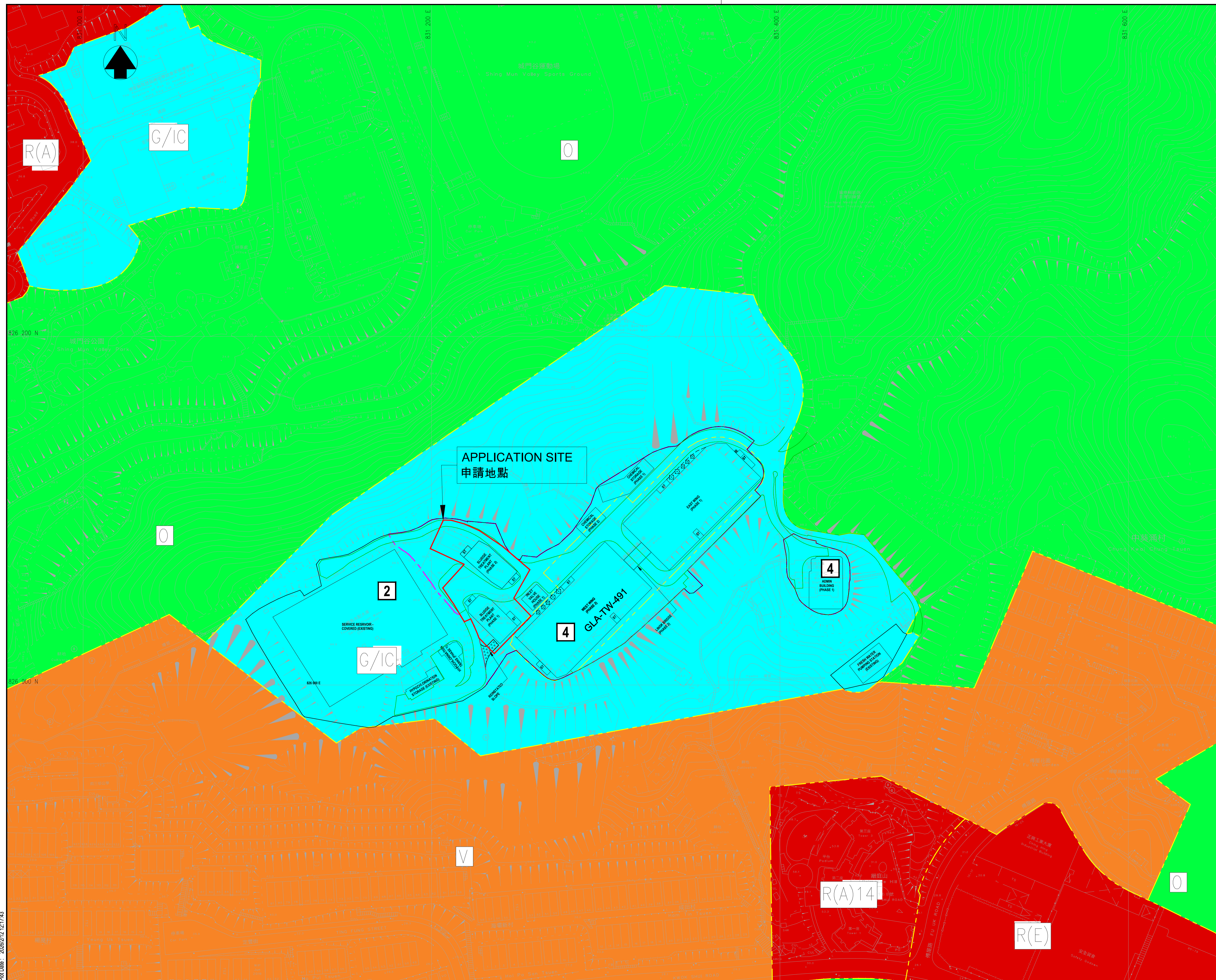

| Revision | Date | Description |         |       | Initial |
|----------|------|-------------|---------|-------|---------|
|          |      | Designed    | Checked | Drawn |         |
|          |      |             |         |       |         |
|          |      |             |         |       |         |

Approved

Agreement No. CE 82/2022 (WS)

Contract Title  
IN - SITU REPROVISIONING OF TSUEN WAN WATER TREATMENT WORKS - INVESTIGATION, DESIGN AND CONSTRUCTION

Drawing Title  
MASTER LAYOUT PLAN WITH OUTLINE ZONING PLAN

Drawing No. **FIGURE 1** Revision -

Scale  
A1 1 : 500  
A3 1 : 1000



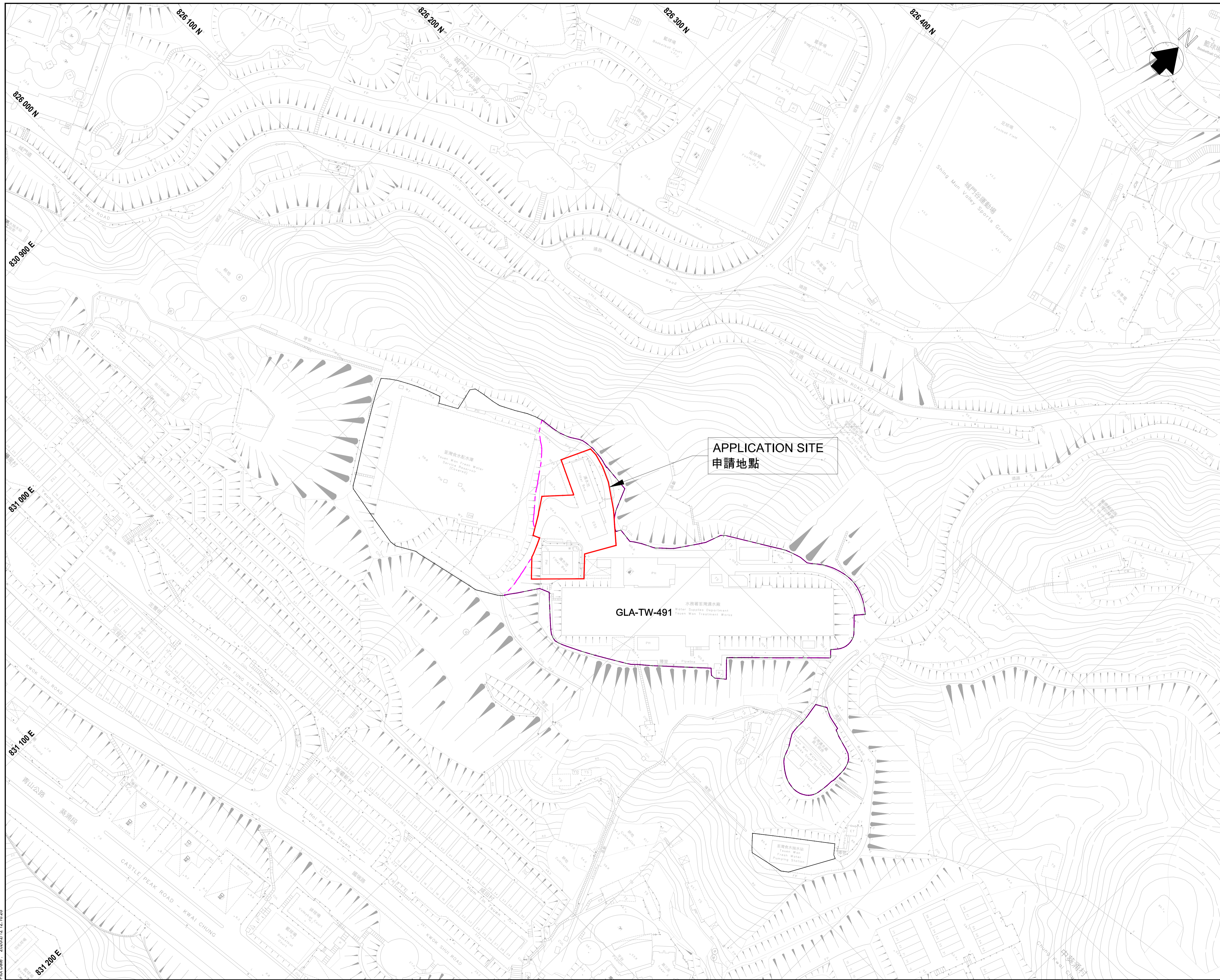

© Copyright by Binnies Hong Kong Limited

- LEGENDS:**
- APPLICATION SITE BOUNDARY
  - OVERALL DEVELOPMENT SITE BOUNDARY FOR REPROVISION OF TSUEN WAN WATER TREATMENT WORKS
  - GLA BOUNDARY

| Revision | Date | Description |         |       | Initial |
|----------|------|-------------|---------|-------|---------|
|          |      | Designed    | Checked | Drawn |         |
|          |      |             |         |       |         |
|          |      |             |         |       |         |

Approved: \_\_\_\_\_

Agreement No. CE 82/2022 (WS)

Contract Title  
IN - SITU REPROVISIONING OF TSUEN WAN WATER TREATMENT WORKS - INVESTIGATION, DESIGN AND CONSTRUCTION

Drawing Title  
LOCATION PLAN

Drawing No. **FIGURE 2**      Revision: -

Scale  
A1 1 : 1000  
A3 1 : 2000



Plot Date: 2026/01/12 16:28

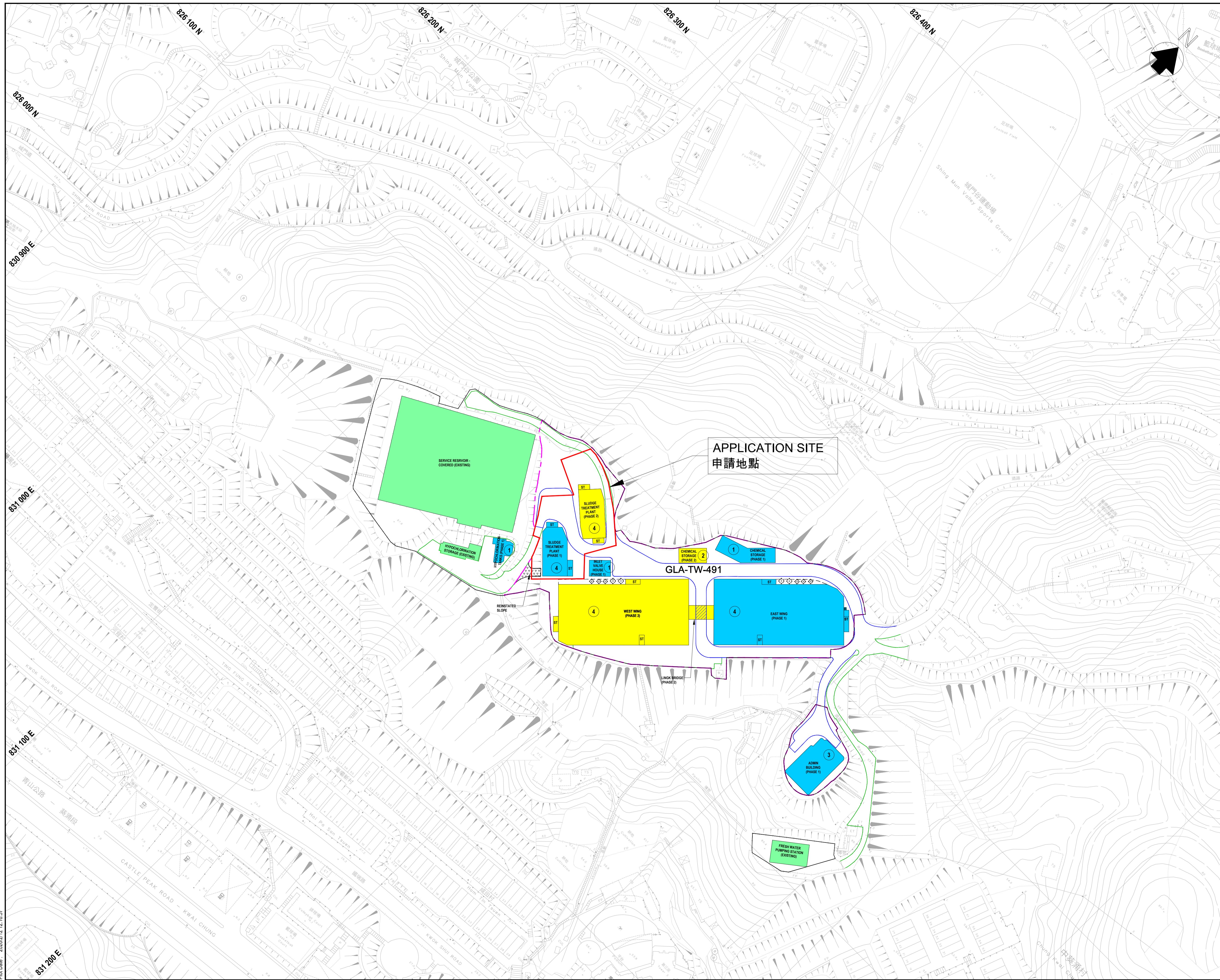

© Copyright by Binnies Hong Kong Limited

- LEGENDS**
- EXISTING FACILITIES
  - NEW FACILITIES (PHASE 1)
  - NEW FACILITIES (PHASE 2)
  - REINSTATED SLOPE
  - DRIVEWAY UNDER BUILDING
  - PAVED CONCRETE BOUNDARY
  - PERMANENT DRIVEWAY
  - OXYGEN TANK (OUTDOOR AREA)
  - APPLICATION SITE BOUNDARY
  - OVERALL DEVELOPMENT SITE BOUNDARY FOR REPROVISION OF TSUEN WAN WATER TREATMENT WORKS
  - GLA BOUNDARY
  - BUILDING HEIGHT (NO. OF STORES)

| Revision | Date | Description |         |       | Initial |
|----------|------|-------------|---------|-------|---------|
|          |      | Designed    | Checked | Drawn |         |
|          |      |             |         |       |         |
| Initial  |      |             |         |       |         |
| Date     |      |             |         |       |         |

Approved

Agreement No. CE 82/2022 (WS)

Contract Title  
IN - SITU REPROVISIONING OF TSUEN WAN WATER TREATMENT WORKS - INVESTIGATION, DESIGN AND CONSTRUCTION

Drawing Title  
MASTER LAYOUT PLAN

Drawing No. **FIGURE 3**      Revision -

Scale  
A1 1 : 1000  
A3 1 : 2000



Plot Date : 2026/01/12 16:57

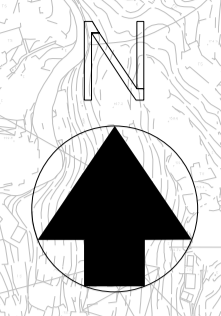

- LEGEND:**
- APPLICATION SITE BOUNDARY
  - - - OVERALL DEVELOPMENT SITE BOUNDARY FOR REPROVISION OF TSUEN WAN WATER TREATMENT WORKS
  - GLA BOUNDARY
  - ACCESS FROM MAIN ROAD TO THE APPLICATION SITE
  - ACCESS FROM THE APPLICATION SITE TO MAIN ROAD

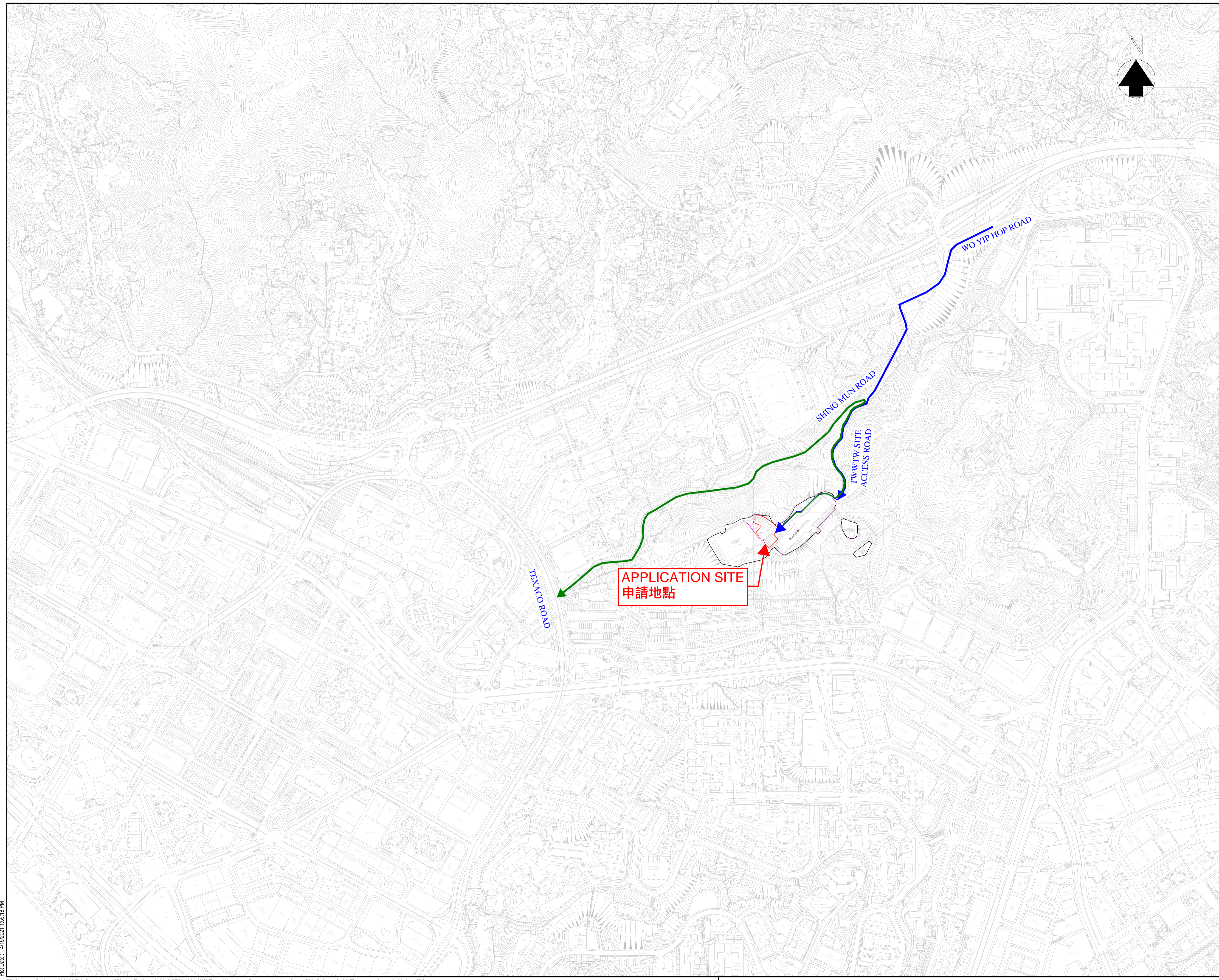

| Revision | Date  | Description |         |       | Initial |
|----------|-------|-------------|---------|-------|---------|
|          |       | Designed    | Checked | Drawn |         |
| Initial  |       | LYS         | SFL     | SZ    | SFL     |
| Date     | 02/24 | 02/24       | 02/24   | 02/24 | 02/24   |

Approved

Contract No. CE 82/2022 (WS)

Contract Title  
IN - SITU REPROVISIONING OF TSUEN WAN WATER TREATMENT WORKS - INVESTIGATION, DESIGN AND CONSTRUCTION

Drawing Title  
**SITE ACCESS PLAN**

Drawing No. **FIGURE 4**      Revision -

Scale A1 1:4000  
A3 1:8000



LEGEND:

- APPLICATION SITE BOUNDARY
- DEVELOPMENT SITE AREA BOUNDARY
- GLA BOUNDARY
- → FIGURE NUMBER AND VIEW DIRECTION

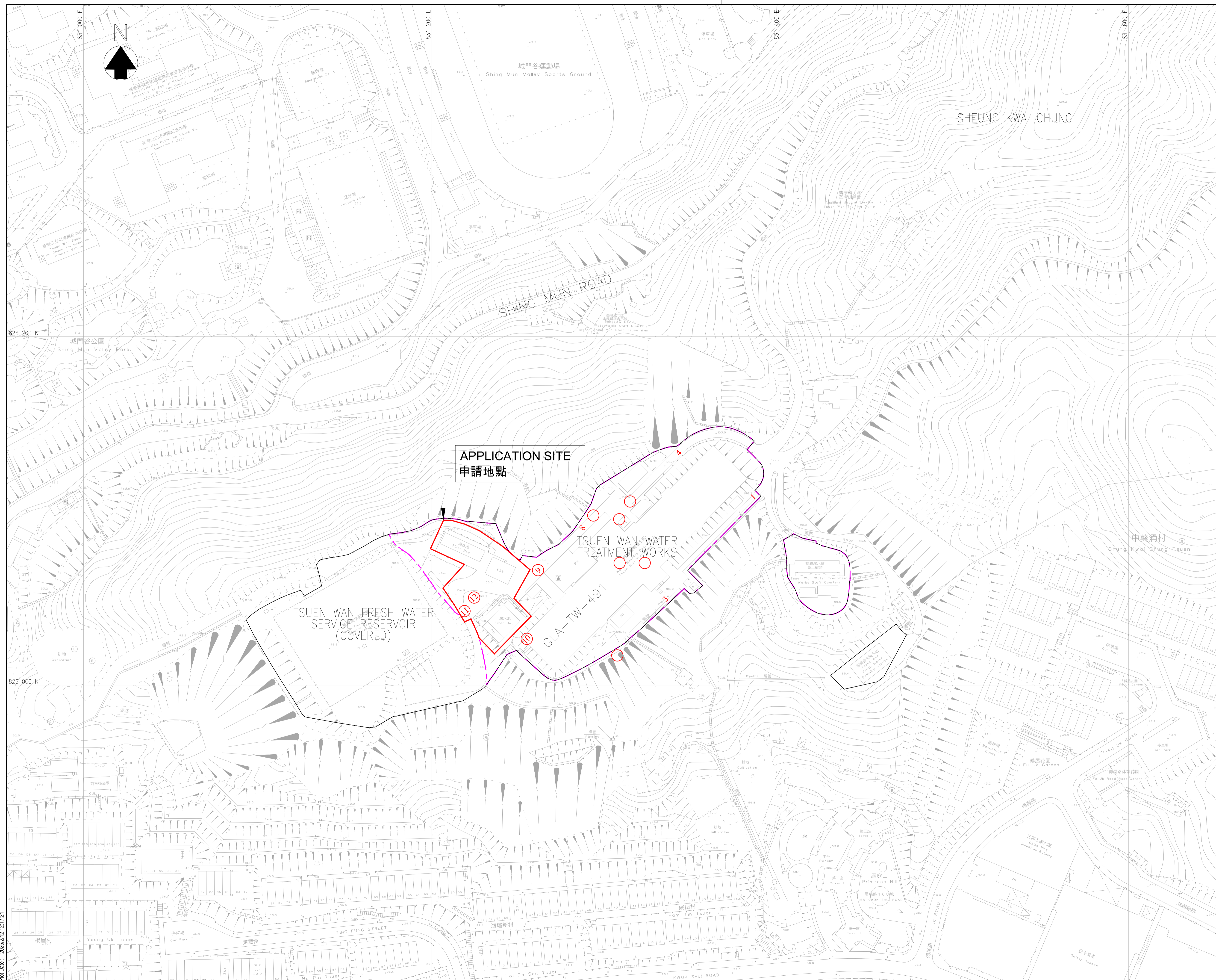

| Revision | Date  | Description |         |       | Initial |
|----------|-------|-------------|---------|-------|---------|
|          |       | Designed    | Checked | Drawn |         |
| Initial  | —     | —           | —       | SZ    | LB      |
| Date     | 08/25 | 08/25       | 08/25   | 08/25 | 08/25   |

Approved

Agreement No. CE 82/2022 (WS)

Contract Title  
IN - SITU REPROVISIONING OF TSUEN WAN WATER TREATMENT WORKS - INVESTIGATION, DESIGN AND CONSTRUCTION

Drawing Title  
EXISTING SITE PHOTO RECORD PLAN

Drawing No. **FIGURE 5** Revision —

Scale A1 1 : 1000 A3 1 : 2000



**FIGURE 6**

**Site Photo 1 - Existing Main Gate to TWWTW**



**FIGURE 7**  
**Site Photo 2 - Existing Pumping House**



**FIGURE 8**

**Site Photo 3 - Existing Dangerous Good Containers and Pumping House**



**FIGURE 9**

**Site Photo 4 - Existing Access Road**



**FIGURE 10**  
**Site Photo 5 - Existing On-site Chlorine Generation**



**FIGURE 11**  
**Site Photo 6 - Existing On-site Chlorine Generation**



**FIGURE 12**

**Site Photo 7 - Existing Chlorination House (Not in Used)**



**FIGURE 13**

**Site Photo 8 - Existing Chlorination House (Not in Used)**



**FIGURE 14**

**Site Photo 9 - Existing Inlet Valve House and E&M Workshop**



## FIGURE 15

### Site Photo 10 - Existing Sludge Holding Tanks



**FIGURE 16**

**Site Photo 11 - Existing West Wing and Sludge Holding Tanks**



**FIGURE 17**

**Site Photo 12 - Existing Access Road and Washwater Recovery Tanks**



**FIGURE 18**

**Site Photo 13 - Existing East Wing**



**FIGURE 19**  
**Site Photo 14 - Existing West Wing**



**FIGURE 20**

**Site Photo 15 - Junction of Shing Mun Road to TWWTW**



**FIGURE 21**

**Site Photo 16 - Access Road to TWWTW**





| Revision | Date | Description |         |       | Initial |
|----------|------|-------------|---------|-------|---------|
|          |      | Designed    | Checked | Drawn |         |
|          |      |             |         |       |         |
|          |      |             |         |       |         |

Approved

Agreement No.  
CE 82/2022 (WS)

Contract Title  
IN - SITU REPROVISIONING OF TSUEN WAN WATER TREATMENT WORKS - INVESTIGATION, DESIGN AND CONSTRUCTION

Drawing Title  
**RENDERING**

|                                 |               |
|---------------------------------|---------------|
| Drawing No.<br><b>FIGURE 22</b> | Revision<br>- |
|---------------------------------|---------------|

Scale N.T.S.



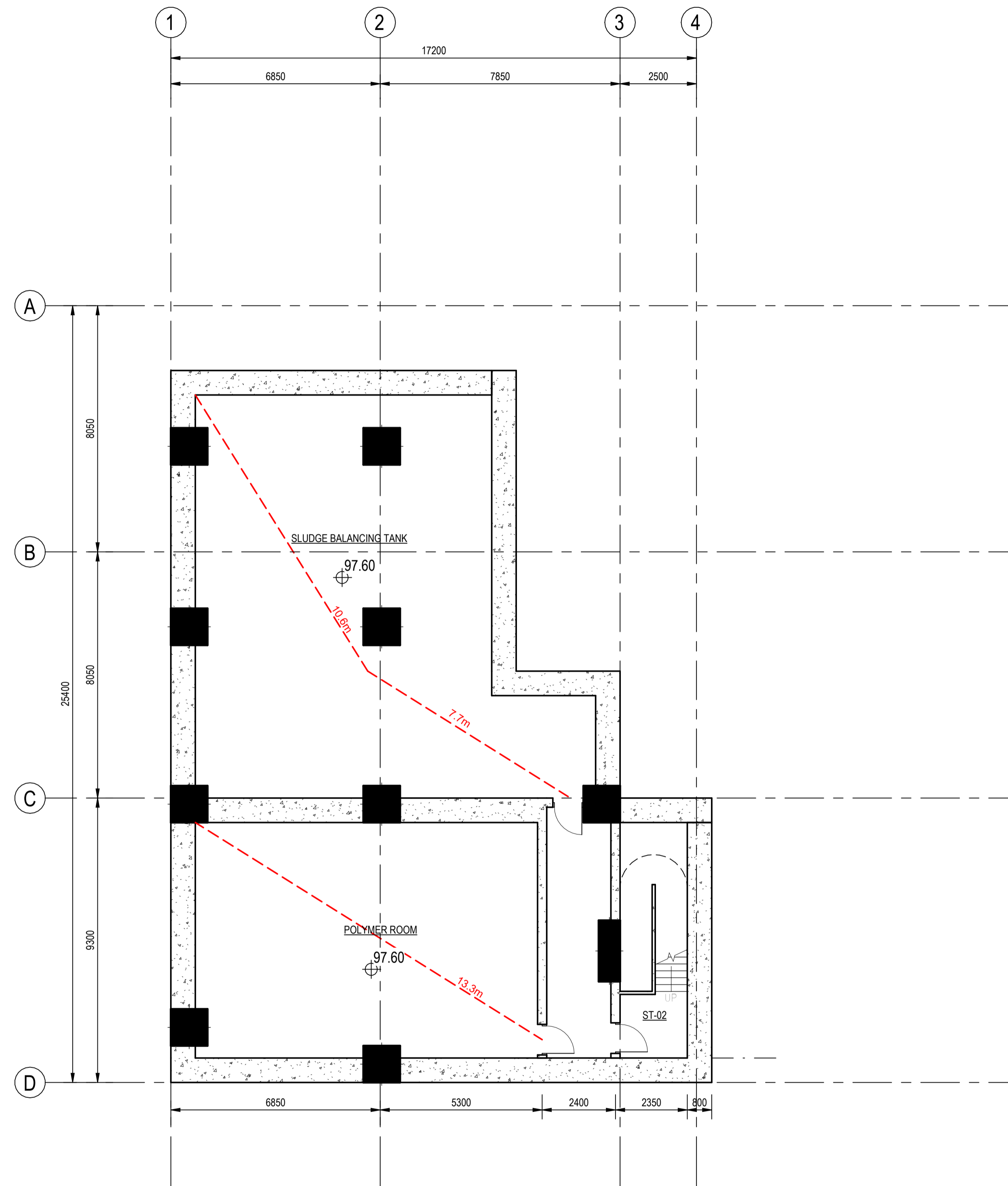

**BASEMENT FLOOR**  
SCALE 1 : 100

| Revision | Date | Description |         |        | Initial |
|----------|------|-------------|---------|--------|---------|
|          |      | Designed    | Checked | Drawn  | Checked |
|          |      | Designer    | Checker | Author |         |
|          |      | Approved    |         |        |         |

Agreement No. CE 82 / 2022 (WS)

Contract Title  
IN - SITU REPROVISIONING OF TSUEN WAN WATER TREATMENT WORKS - INVESTIGATION, DESIGN AND CONSTRUCTION -

Drawing Title  
GENERAL ARRANGEMENT - SLUDGE TREATMENT PLANT (PHASE 1) - BASEMENT FLOOR

Drawing No. FIGURE 23

Scale A1 1 : 100

Client  
**水務署**  
Water Supplies Department

Consultant  
**binnies**  
BINNIES HONG KONG LIMITED  
賓尼斯工程顧問有限公司

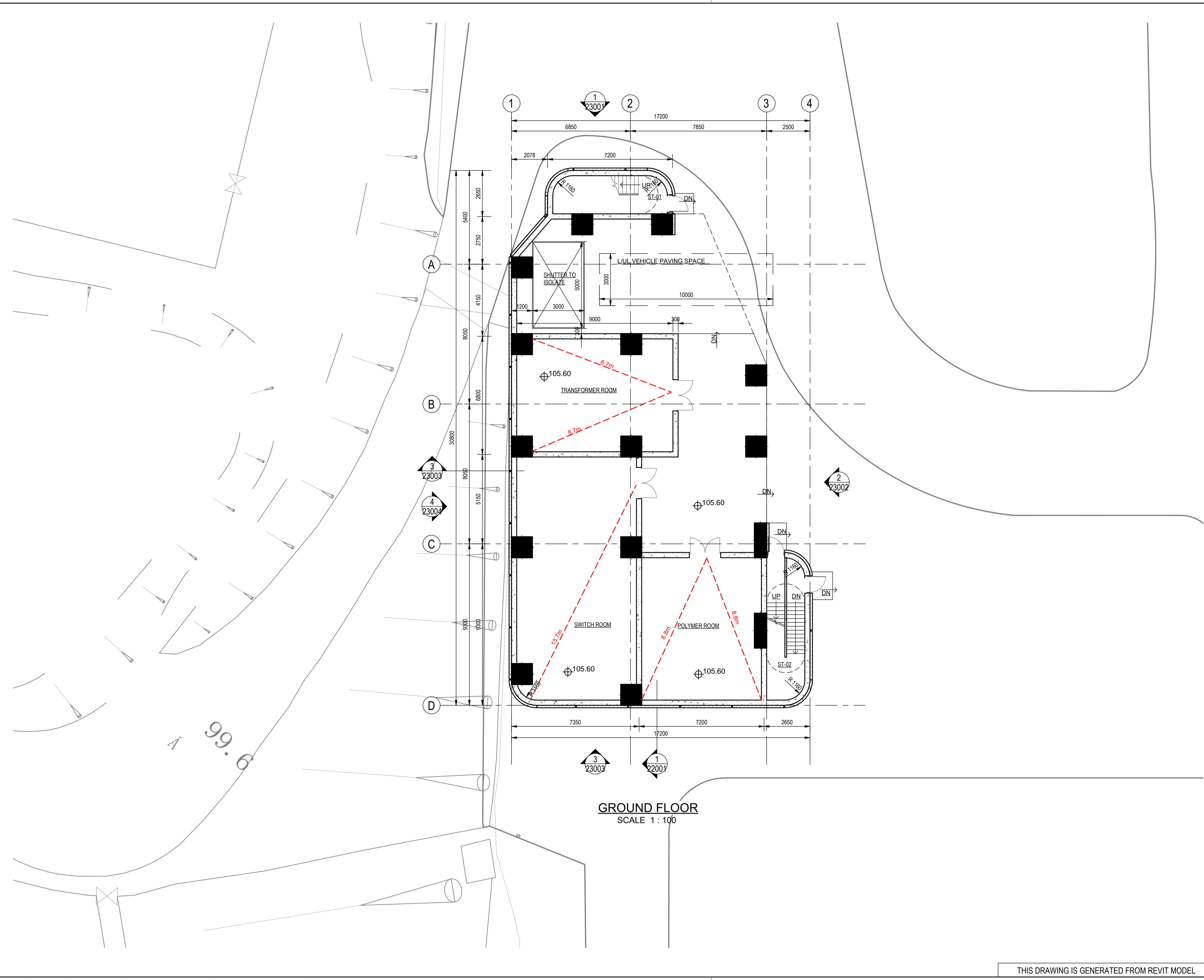

| Revision | Date | Description |         |        | Initial |
|----------|------|-------------|---------|--------|---------|
|          |      | Designed    | Checked | Drawn  | Checked |
|          |      | Designer    | Checker | Author |         |

Approved

Agreement No. CE 82 / 2022 (WS)

Contract Title  
IN - SITU REPROVISIONING OF TSUEN WAN WATER TREATMENT WORKS - INVESTIGATION, DESIGN AND CONSTRUCTION -

Drawing Title  
GENERAL ARRANGEMENT - SLUDGE TREATMENT PLANT (PHASE 1) - GROUND FLOOR

Drawing No. FIGURE 24

Scale A1 1:100

Client  
**水務署**  
Water Supplies Department

Consultant  
**binnies**  
BINNIES HONG KONG LIMITED  
賓尼斯工程顧問有限公司

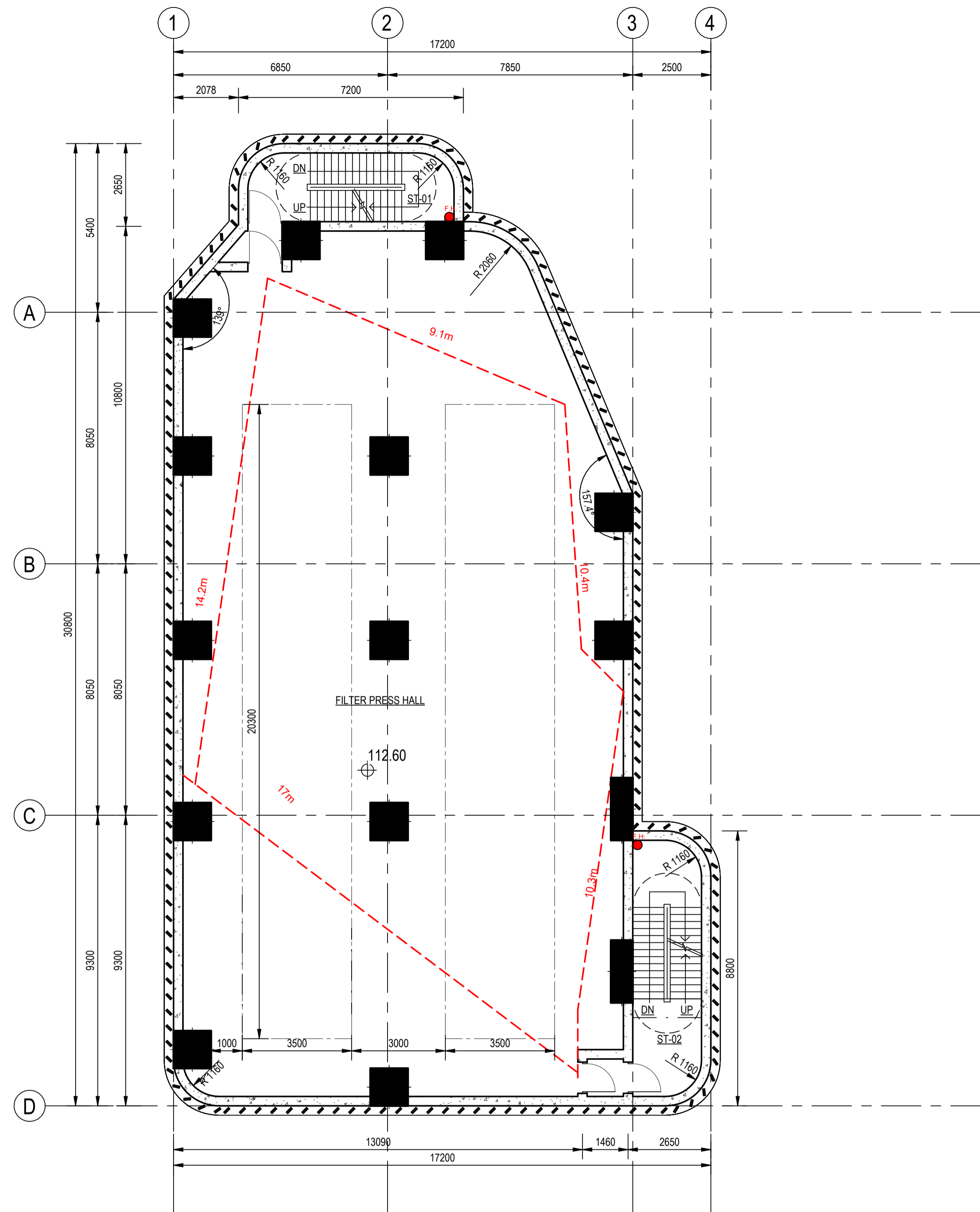

FIRST FLOOR  
SCALE 1 : 100

| Revision | Date     | Description |         |       | Initial |
|----------|----------|-------------|---------|-------|---------|
|          |          | Designed    | Checked | Drawn |         |
| Initial  | Designer | Checker     | Author  |       |         |

Approved

Agreement No. CE 82 / 2022 (WS)

Contract Title  
IN - SITU REPROVISIONING OF TSUEN WAN WATER TREATMENT WORKS - INVESTIGATION, DESIGN AND CONSTRUCTION -

Drawing Title  
GENERAL ARRANGEMENT - SLUDGE TREATMENT PLANT (PHASE 1) - FIRST FLOOR

Drawing No. FIGURE 25

Scale A1 1 : 100

Client  
 水務署  
Water Supplies Department

Consultant  
 BINNIES HONG KONG LIMITED  
賓尼斯工程顧問有限公司

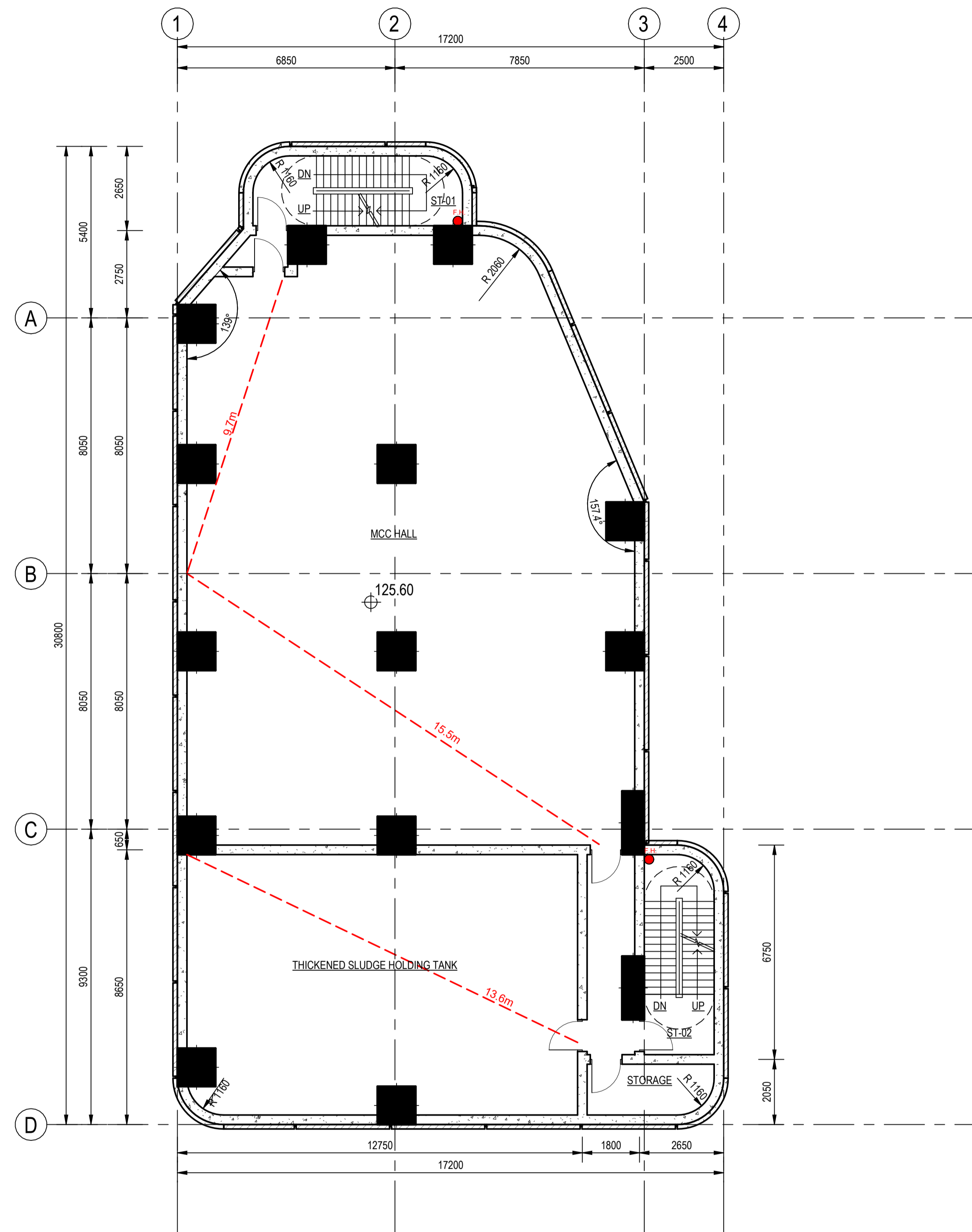

**SECOND FLOOR**  
SCALE 1 : 100

| Revision | Date     | Description |         |       | Initial |
|----------|----------|-------------|---------|-------|---------|
|          |          | Designed    | Checked | Drawn |         |
| Initial  | Designer | Checker     | Author  |       |         |

Approved

Agreement No.  
CE 82 / 2022 (WS)

Contract Title  
IN - SITU REPROVISIONING OF TSUEN WAN WATER TREATMENT WORKS - INVESTIGATION, DESIGN AND CONSTRUCTION -

Drawing Title  
GENERAL ARRANGEMENT - SLUDGE TREATMENT PLANT (PHASE 1) - SECOND FLOOR

Drawing No. **FIGURE 26** Revision

Scale  
A1 1 : 100

Client  
 水務署  
Water Supplies Department

Consultant  
 BINNIES HONG KONG LIMITED  
賓尼斯工程顧問有限公司

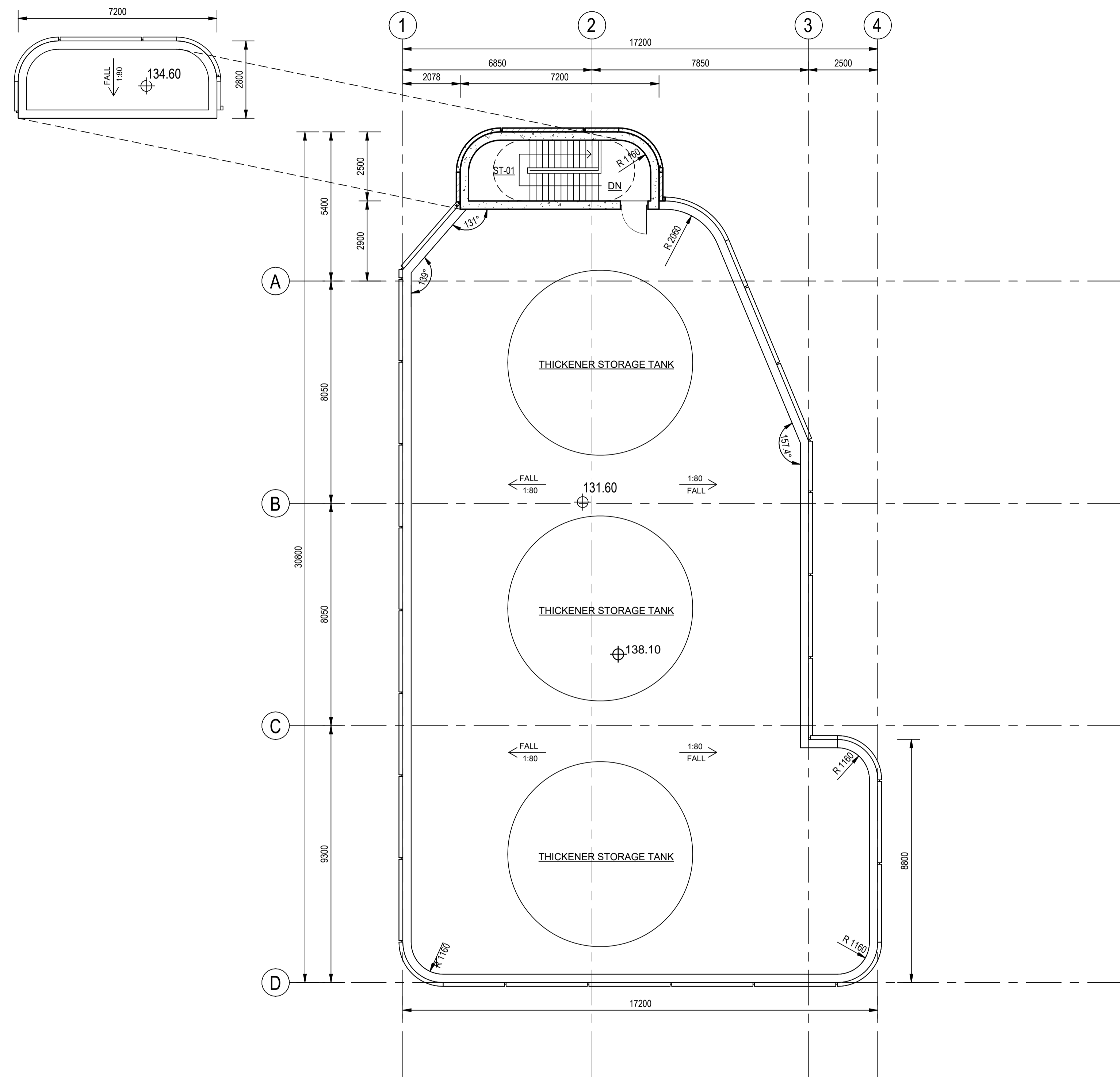

**ROOF FLOOR**  
SCALE 1 : 100

| Revision | Date | Description |         |        | Initial |
|----------|------|-------------|---------|--------|---------|
|          |      | Designed    | Checked | Drawn  | Checked |
|          |      | Designer    | Checker | Author |         |
| Approved |      |             |         |        |         |

Agreement No.  
CE 82 / 2022 (WS)

Contract Title  
IN - SITU REPROVISIONING OF TSUEN WAN WATER TREATMENT WORKS - INVESTIGATION, DESIGN AND CONSTRUCTION -

Drawing Title  
GENERAL ARRANGEMENT - SLUDGE TREATMENT PLANT (PHASE 1) - ROOF FLOOR

Drawing No. **FIGURE 27** Revision

Scale  
A1 1 : 100

Client  
 水務署  
Water Supplies Department

Consultant  
 BINNIES HONG KONG LIMITED  
賓尼斯工程顧問有限公司

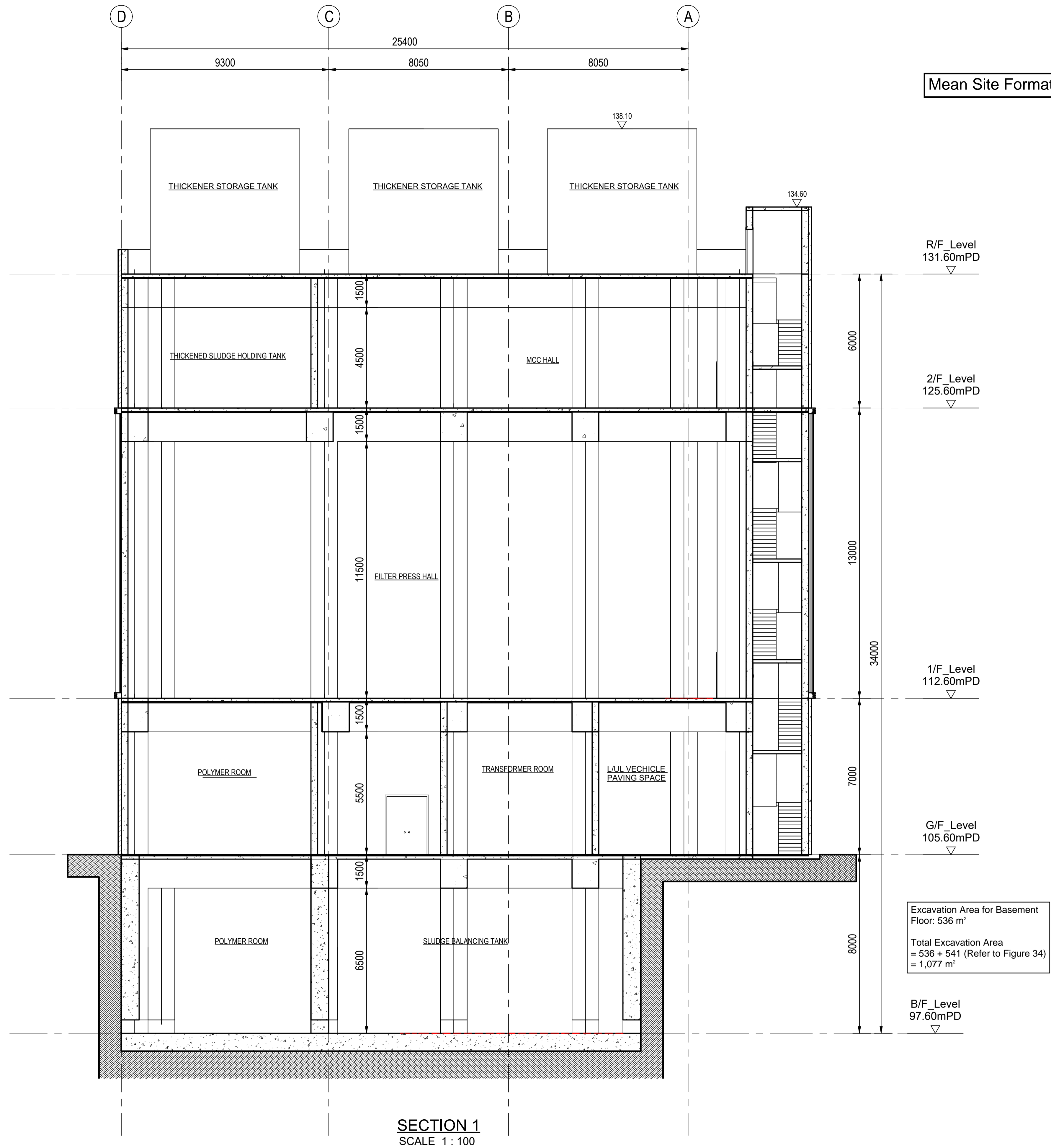

Mean Site Formation Level: 96.10 mPD

SECTION 1  
SCALE 1 : 100

| Revision | Date | Description |         |        | Initial |
|----------|------|-------------|---------|--------|---------|
|          |      | Designed    | Checked | Drawn  |         |
| Initial  |      | Designer    | Checker | Author |         |
| Date     |      |             |         |        |         |
| Approved |      |             |         |        |         |

Agreement No. CE 82 / 2022 (WS)  
 Contract Title  
 IN - SITU REPROVISIONING OF TSUEN WAN WATER TREATMENT WORKS - INVESTIGATION, DESIGN AND CONSTRUCTION -

Drawing Title  
 GENERAL ARRANGEMENT - SLUDGE TREATMENT PLANT (PHASE 1) - SECTION 1

Drawing No. FIGURE 28

Scale A1 1 : 100



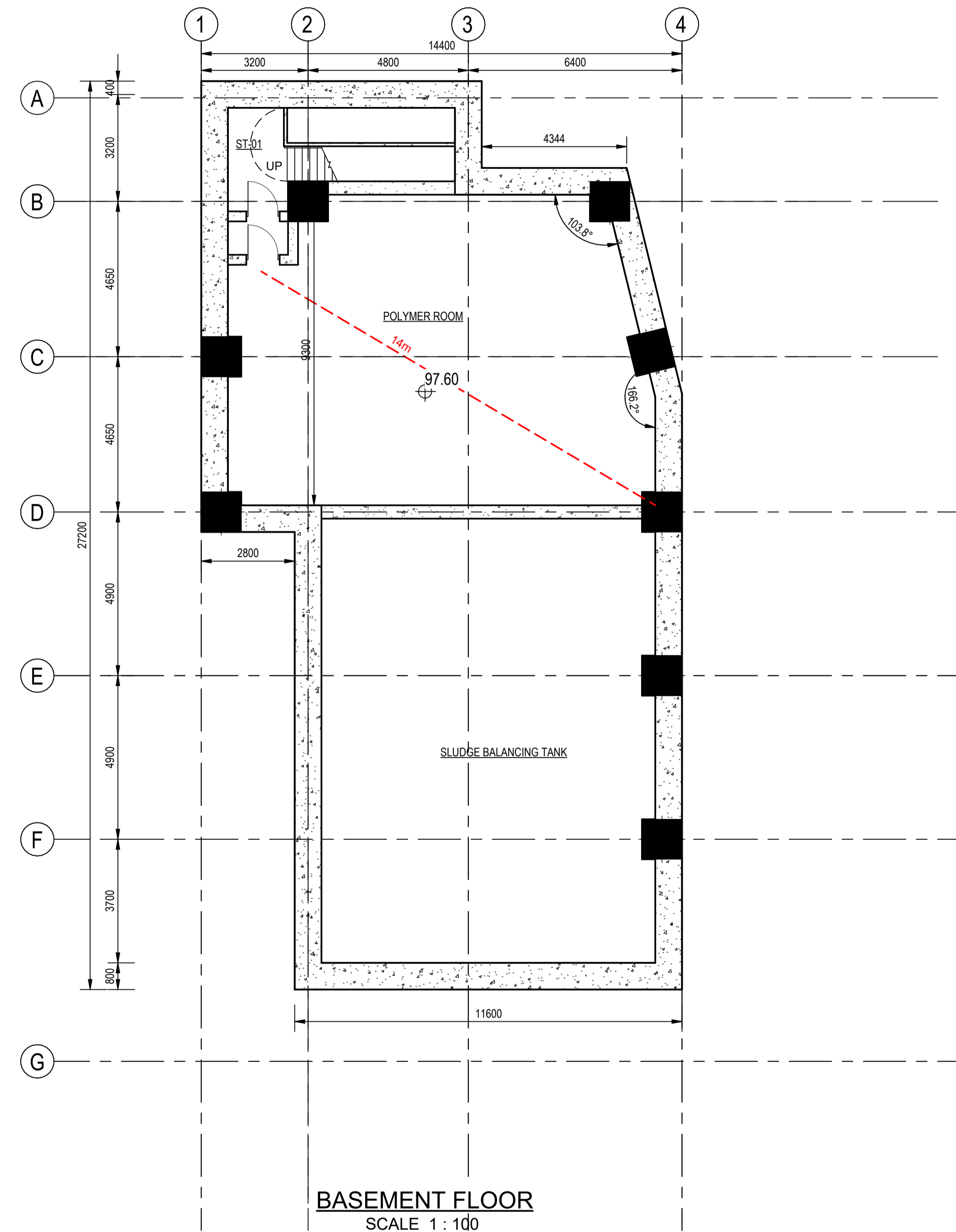

**BASEMENT FLOOR**  
SCALE 1 : 100

| Revision | Date     |         | Description |         | Initial |
|----------|----------|---------|-------------|---------|---------|
|          | Designed | Checked | Drawn       | Checked |         |
| Initial  | Designer | Checker | Author      |         |         |
| Date     |          |         |             |         |         |

Approved

Agreement No.  
CE 82 / 2022 (WS)

Contract Title  
IN - SITU REPROVISIONING OF TSUEN WAN WATER TREATMENT WORKS - INVESTIGATION, DESIGN AND CONSTRUCTION -

Drawing Title  
GENERAL ARRANGEMENT - SLUDGE TREATMENT PLANT (PHASE 2) - BASEMENT FLOOR

|                          |          |
|--------------------------|----------|
| Drawing No.<br>FIGURE 29 | Revision |
|--------------------------|----------|

Scale  
A1 1 : 100

Client  

**水務署**  
Water Supplies Department

Consultant  
  
**binnies**  
BINNIES HONG KONG LIMITED  
賓尼斯工程顧問有限公司

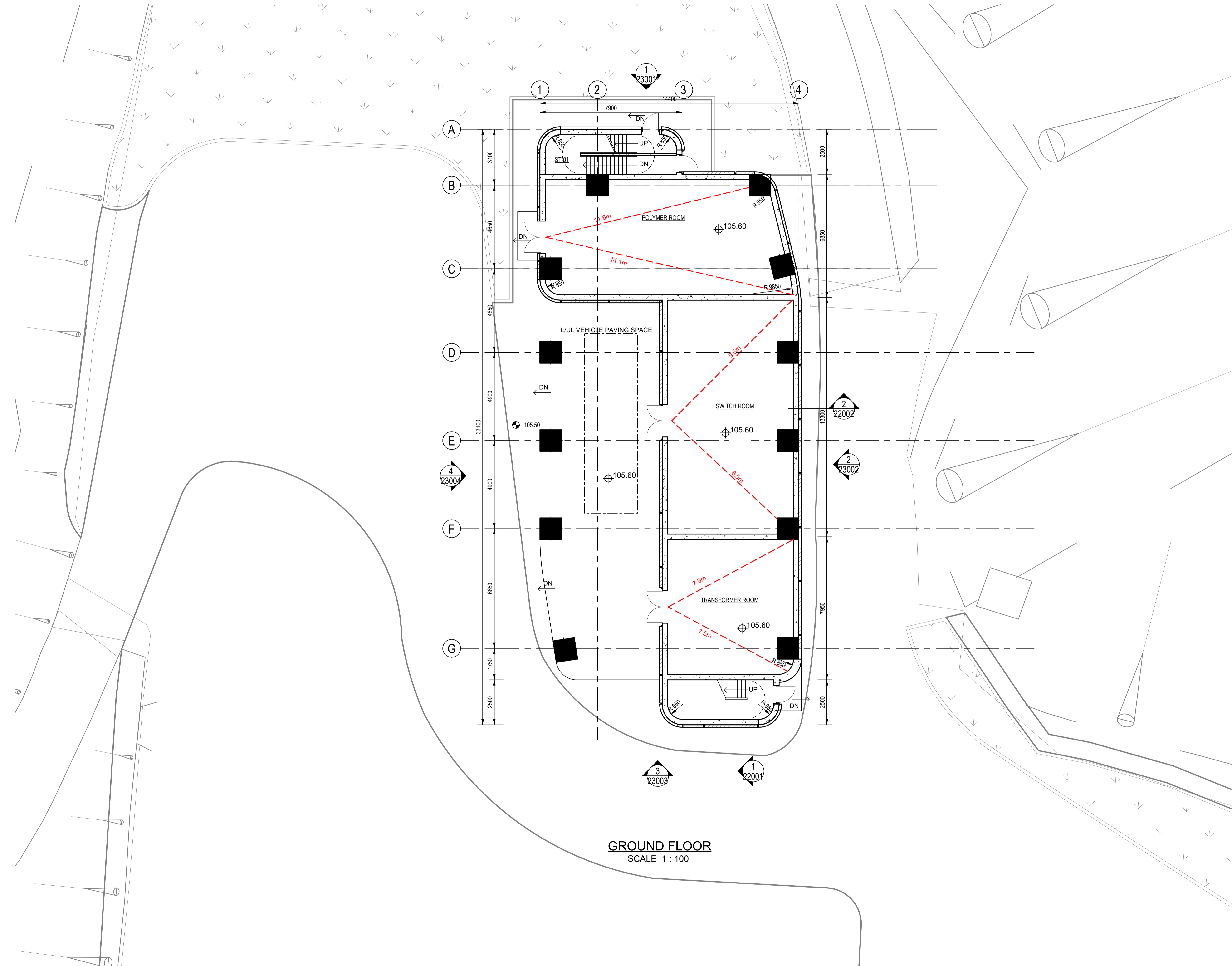

**GROUND FLOOR**  
SCALE 1 : 100

| Revision | Date     | Description |         |       | Initial |
|----------|----------|-------------|---------|-------|---------|
|          |          | Designed    | Checked | Drawn |         |
| Initial  | Designer | Checker     | Author  |       |         |
| Date     |          |             |         |       |         |

Approved

Agreement No. CE 82 / 2022 (WS)

Contract Title  
IN - SITU REPROVISIONING OF TSUEN WAN WATER TREATMENT WORKS - INVESTIGATION, DESIGN AND CONSTRUCTION -

Drawing Title  
GENERAL ARRANGEMENT - SLUDGE TREATMENT PLANT (PHASE 2) - GROUND FLOOR

Drawing No. **FIGURE 30** Revision

Scale A1 1 : 100

Client  
 水務署  
Water Supplies Department

Consultant  
 BINNIES HONG KONG LIMITED  
賓尼斯工程顧問有限公司

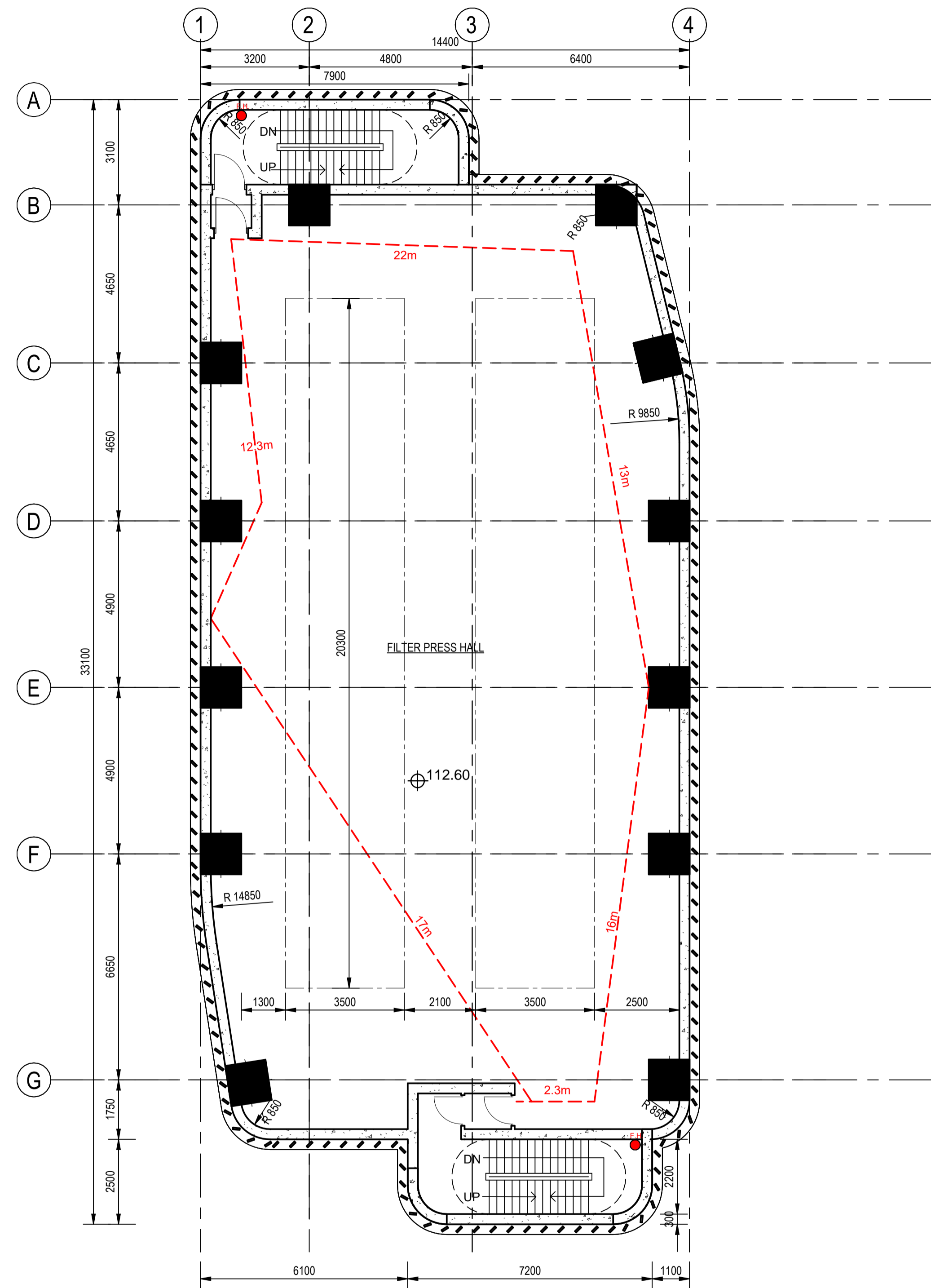

**FIRST FLOOR**  
SCALE 1 : 100

| Revision | Date     | Description |         |       | Initial |
|----------|----------|-------------|---------|-------|---------|
|          |          | Designed    | Checked | Drawn |         |
| Initial  | Designer | Checker     | Author  |       |         |

Approved

Agreement No. CE 82 / 2022 (WS)

Contract Title  
IN - SITU REPROVISIONING OF TSUEN WAN WATER TREATMENT WORKS - INVESTIGATION, DESIGN AND CONSTRUCTION -

Drawing Title  
GENERAL ARRANGEMENT - SLUDGE TREATMENT PLANT (PHASE 2) - FIRST FLOOR

Drawing No. **FIGURE 31** Revision

Scale A1 1 : 100

Client  
 水務署  
Water Supplies Department

Consultant  
 BINNIES HONG KONG LIMITED  
賓尼斯工程顧問有限公司

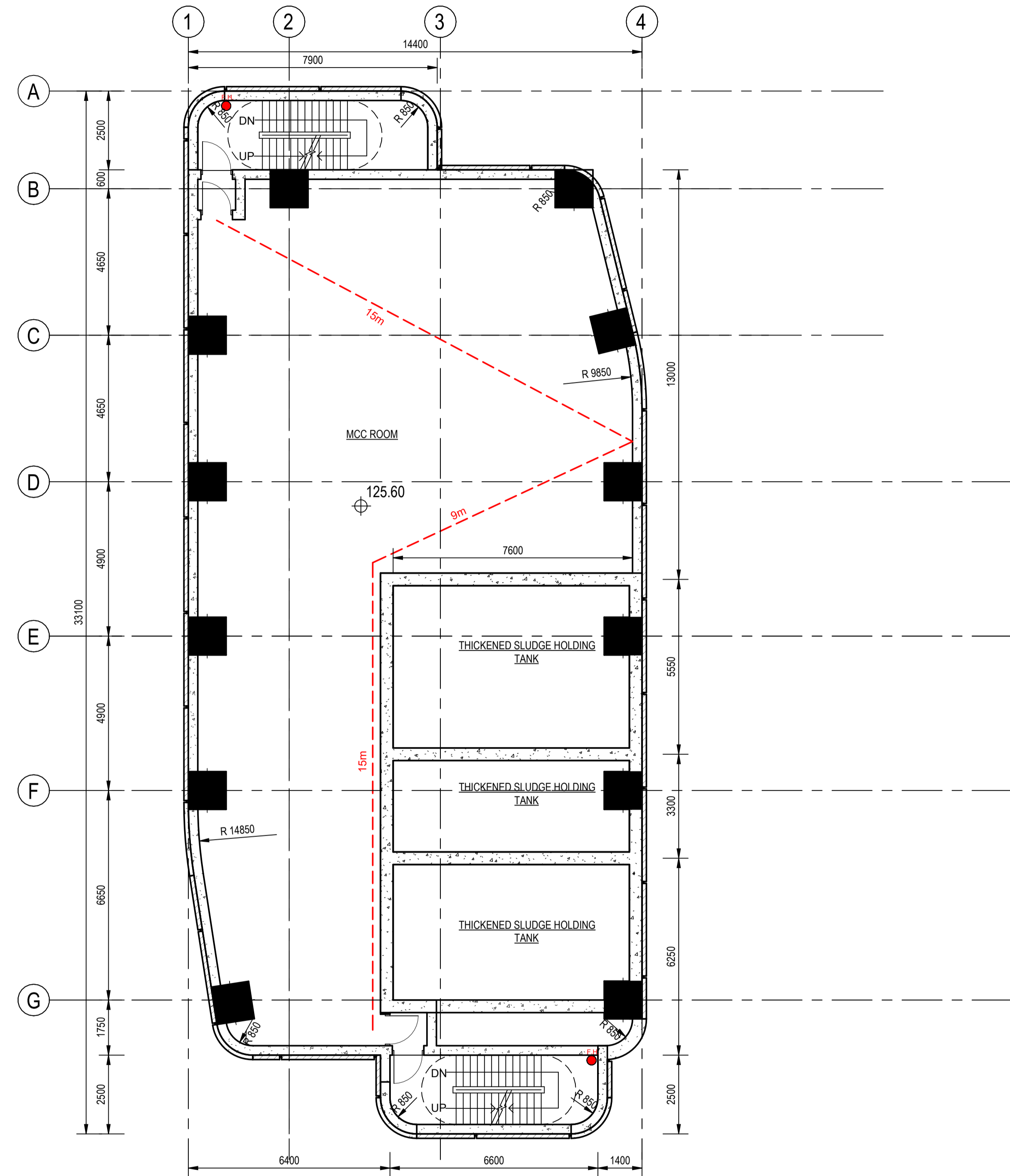

**SECOND FLOOR**  
SCALE 1 : 100

| Revision | Date | Description |         |        | Initial |
|----------|------|-------------|---------|--------|---------|
|          |      | Designed    | Checked | Drawn  | Checked |
|          |      | Designer    | Checker | Author |         |
| Date     |      |             |         |        |         |
| Approved |      |             |         |        |         |

Agreement No.  
CE 82 / 2022 (WS)

Contract Title  
IN - SITU REPROVISIONING OF TSUEN WAN WATER TREATMENT WORKS - INVESTIGATION, DESIGN AND CONSTRUCTION -

Drawing Title  
GENERAL ARRANGEMENT - SLUDGE TREATMENT PLANT (PHASE 2) - SECOND FLOOR

Drawing No. **FIGURE 32** Revision

Scale  
A1 1 : 100

Client  
 水務署  
Water Supplies Department

Consultant  
 **binnies**  
BINNIES HONG KONG LIMITED  
賓尼斯工程顧問有限公司

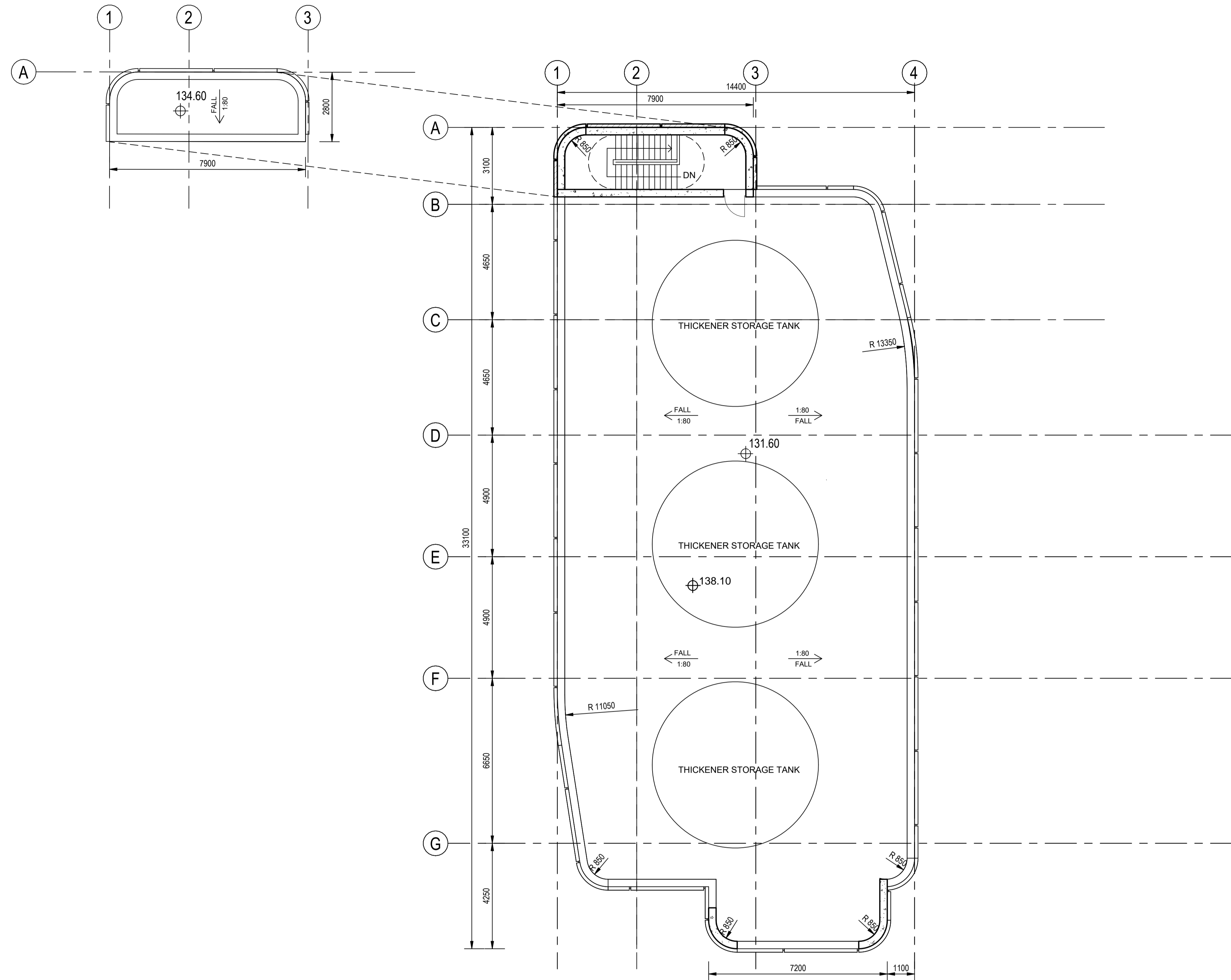

**ROOF FLOOR**  
SCALE 1 : 100

| Revision | Date     | Description |         |       | Initial |
|----------|----------|-------------|---------|-------|---------|
|          |          | Designed    | Checked | Drawn |         |
| Initial  | Designer | Checker     | Author  |       |         |
| Date     |          |             |         |       |         |

Approved

Agreement No.  
CE 82 / 2022 (WS)

Contract Title  
IN - SITU REPROVISIONING OF TSUEN WAN WATER TREATMENT WORKS - INVESTIGATION, DESIGN AND CONSTRUCTION -

Drawing Title  
GENERAL ARRANGEMENT - SLUDGE TREATMENT PLANT (PHASE 2) - ROOF FLOOR

Drawing No. **FIGURE 33** Revision

Scale  
A1 1 : 100

Client  
 水務署  
Water Supplies Department

Consultant  
 BINNIES HONG KONG LIMITED  
賓尼斯工程顧問有限公司

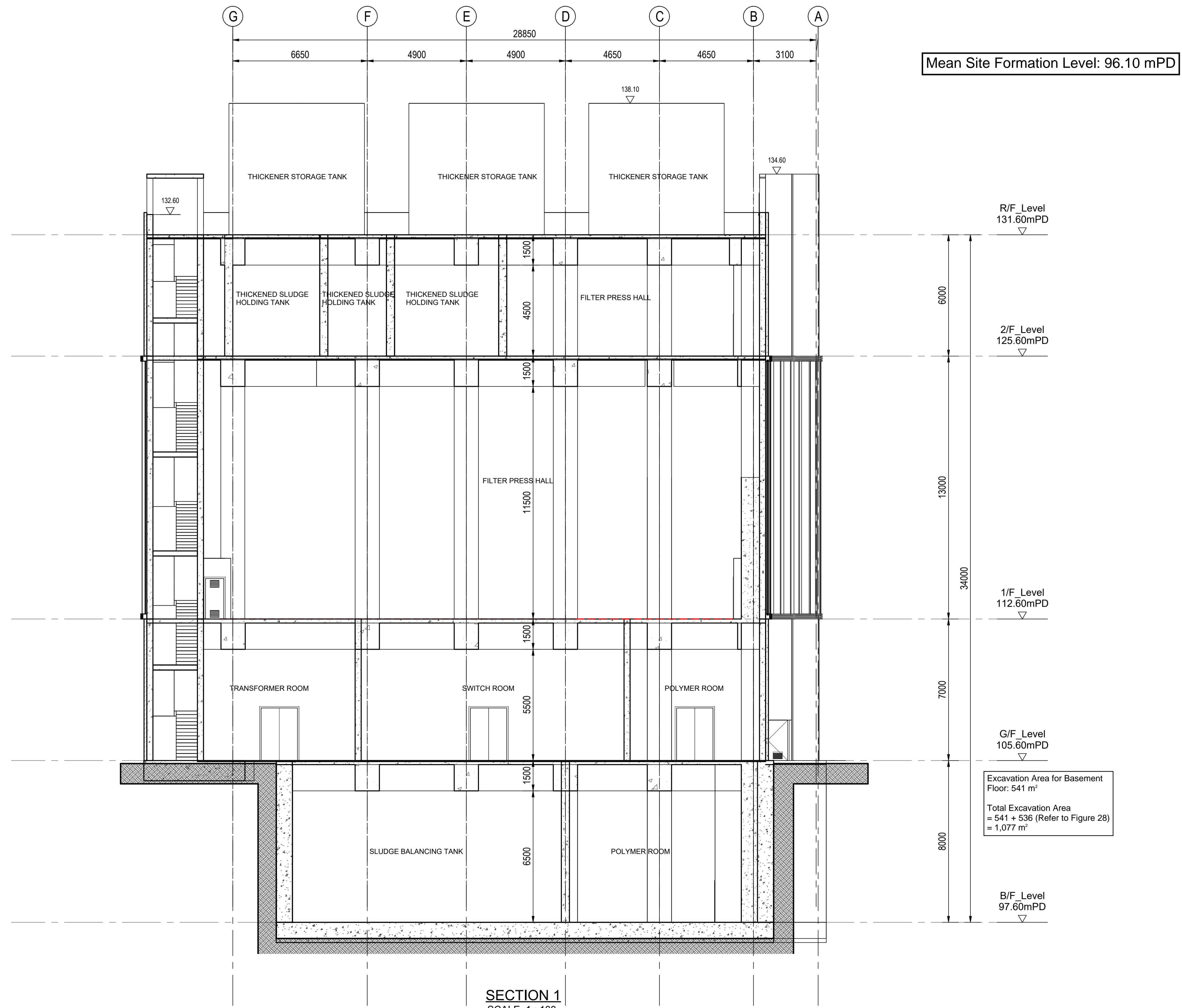

SECTION 1  
SCALE 1 : 100

| Revision | Date | Description |         |        | Initial |
|----------|------|-------------|---------|--------|---------|
|          |      | Designed    | Checked | Drawn  |         |
| Initial  |      | Designer    | Checker | Author |         |

Approved

Agreement No.  
CE 82 / 2022 (WS)

Contract Title  
IN - SITU REPROVISIONING OF TSUEN WAN WATER TREATMENT WORKS - INVESTIGATION, DESIGN AND CONSTRUCTION -

Drawing Title  
GENERAL ARRANGEMENT - SLUDGE TREATMENT PLANT (PHASE 2) - SECTION 1

Drawing No. **FIGURE 34** Revision

Scale  
A1 1 : 100

Client  
 水務署  
Water Supplies Department

Consultant  
 binnies  
BINNIES HONG KONG LIMITED  
賓尼斯工程顧問有限公司

NOTES:

1. THE TREES AT CLOSE PROXIMITY TO THE APPLICATION SITE ARE SHOWN ONLY FOR CLARITY.

LEGEND:

- TREE TO BE REMOVED DUE TO UNDESIRABLE TREES

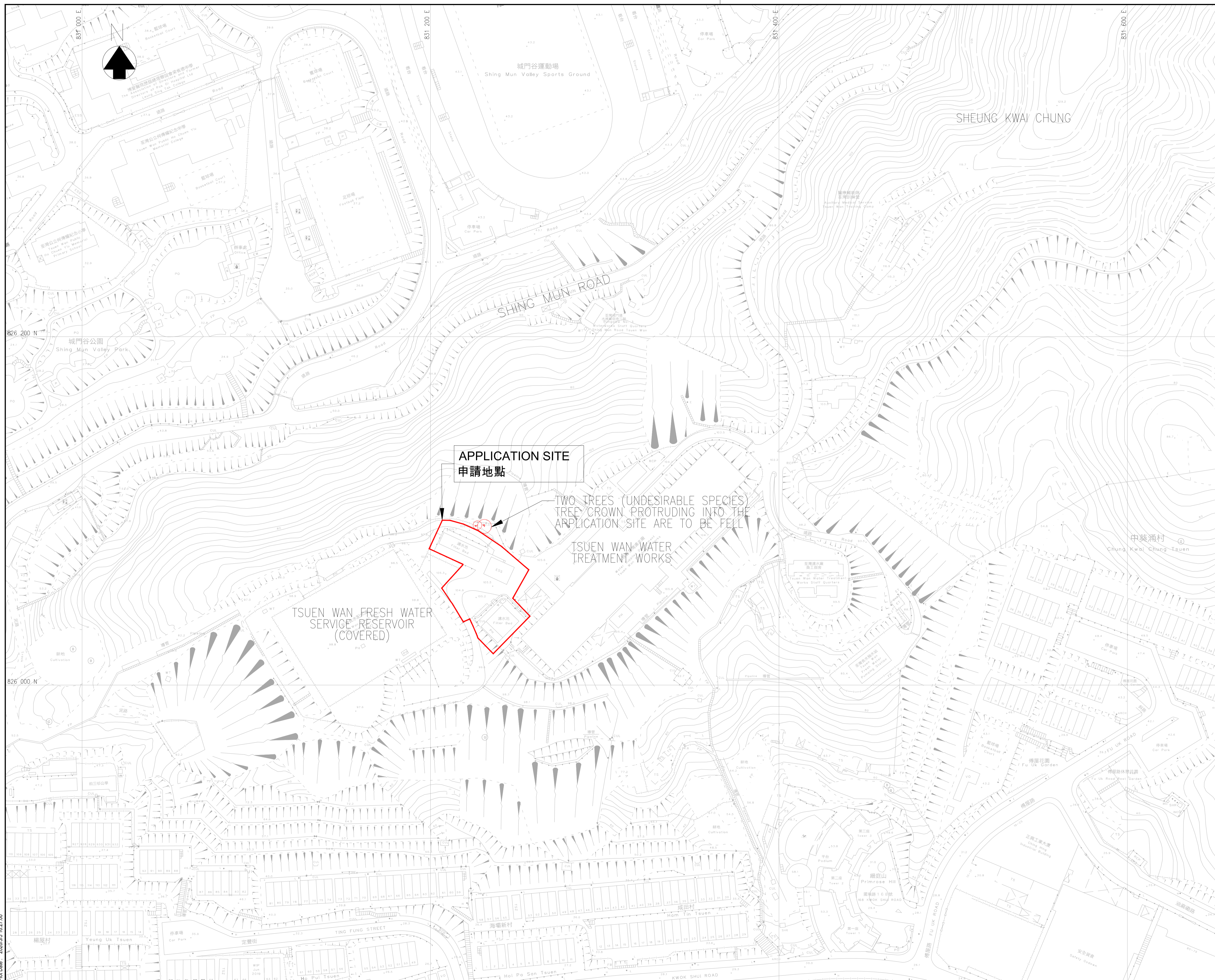

| Revision | Date  | Description |         |       | Initial |
|----------|-------|-------------|---------|-------|---------|
|          |       | Designed    | Checked | Drawn |         |
| Initial  | -     | -           | -       | SZ    | LB      |
| Date     | 08/25 | 08/25       | 08/25   | 08/25 | 08/25   |

Approved

Agreement No. CE 82/2022 (WS)

Contract Title  
IN - SITU REPROVISIONING OF TSUEN WAN WATER TREATMENT WORKS - INVESTIGATION, DESIGN AND CONSTRUCTION

Drawing Title  
TREE FELL LOCATION PLAN

Drawing No. FIGURE 35

Scale  
A1 1 : 1000  
A3 1 : 2000



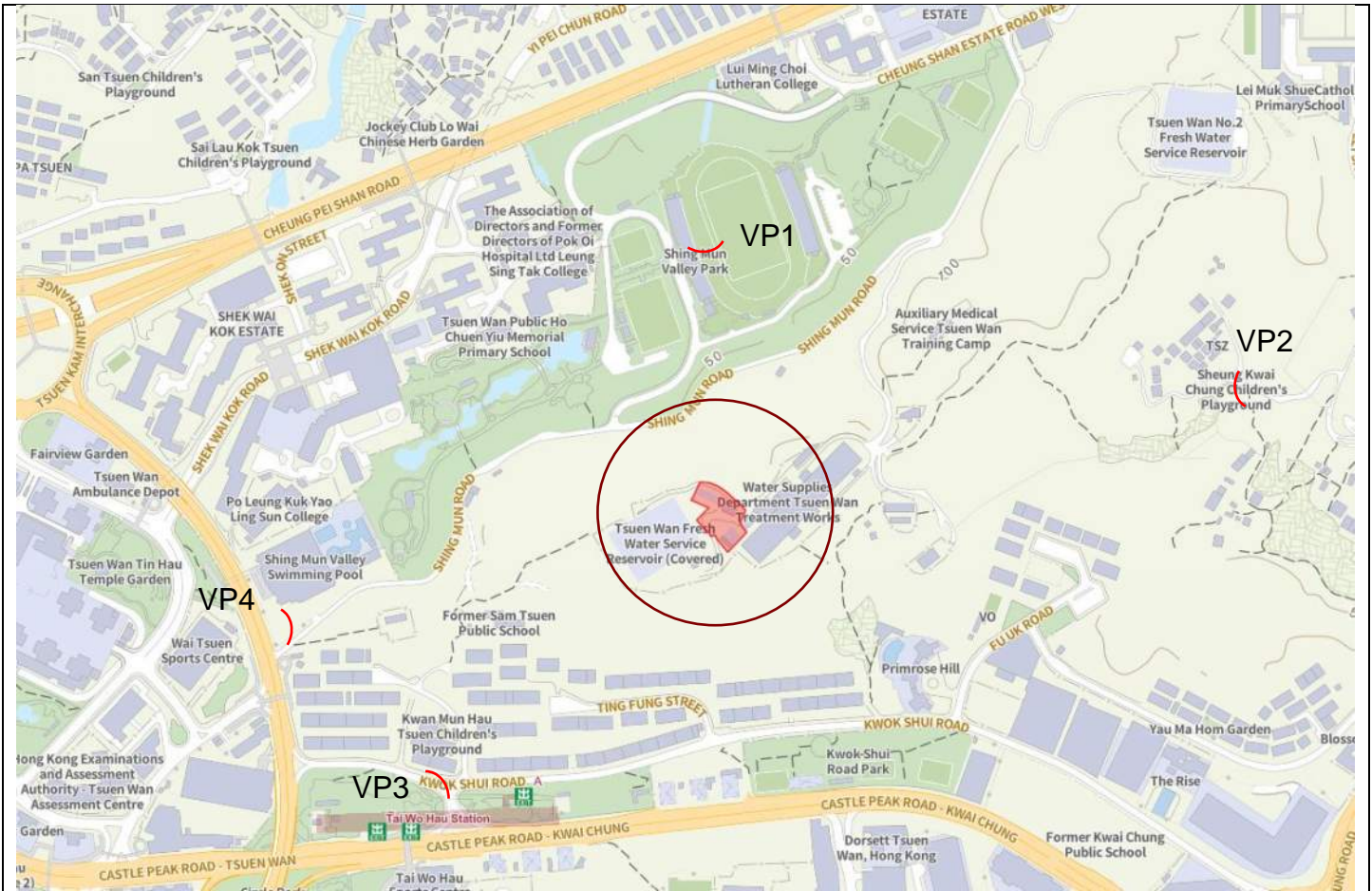

**LEGEND**

- Application Site
- Assessment Area Radius (3 x 40.5 m = 121.5 m)
- ) VP1: Shing Mun Valley Sports Ground
- ) VP2: Junction at Sheung Kwai Chung Children's Play ground
- ) VP3: Kwok Shui Road Park
- ) VP4: Near the Entrance Gate at Shing Mun Valley Swimming Pool

| Figure No.                                                                          | Scale              | Figure Title                                   |
|-------------------------------------------------------------------------------------|--------------------|------------------------------------------------|
| 36                                                                                  | -                  | Assessment Area and Location of Viewing Points |
|  | Date<br>March 2026 | Source<br>Geoinfo Map                          |

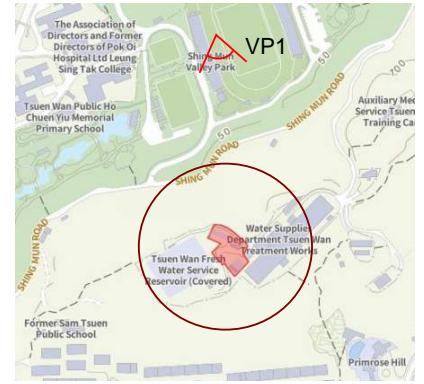

**Key Plan**

**Existing Condition**

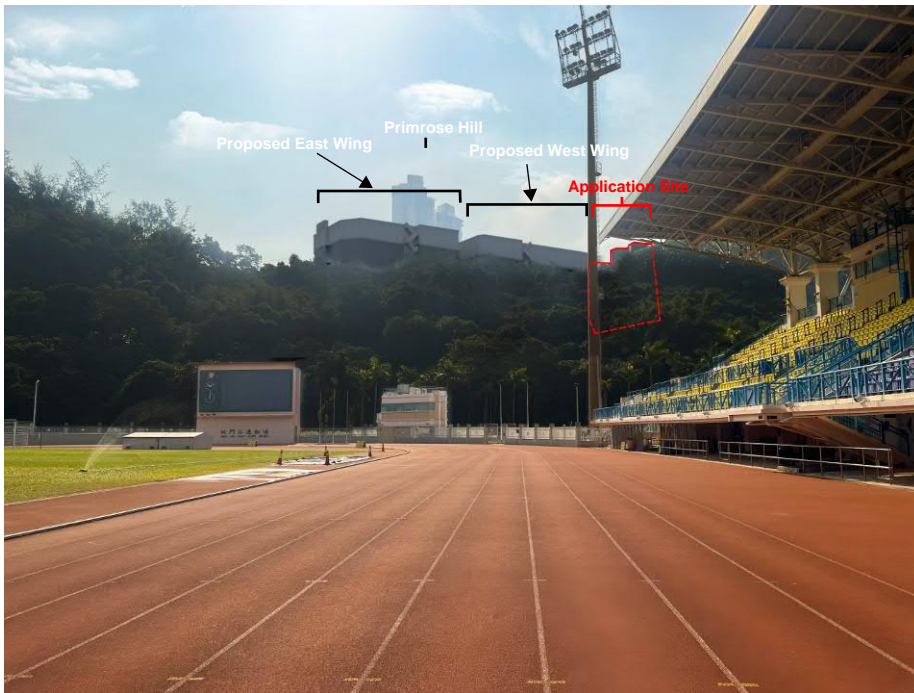

**Proposed Development**

| Figure No.                                                                          | Scale              | Figure Title                                      |
|-------------------------------------------------------------------------------------|--------------------|---------------------------------------------------|
| 37                                                                                  | -                  | Viewing Point 1 - Shing Mun Valley Sports Grounds |
|  | Date<br>March 2026 | Source<br>Photomontage for illustrative purpose   |



**Existing Condition**



**Key Plan**



**Proposed Development**

| Figure No.                                                                          | Scale              | Figure Title                                                        |
|-------------------------------------------------------------------------------------|--------------------|---------------------------------------------------------------------|
| 38                                                                                  | -                  | Viewing Point 2 - Junction at Sheung Kwai Chung Children Playground |
|  | Date<br>March 2026 | Source<br>Photomontage for illustrative purpose                     |



**Existing Condition**

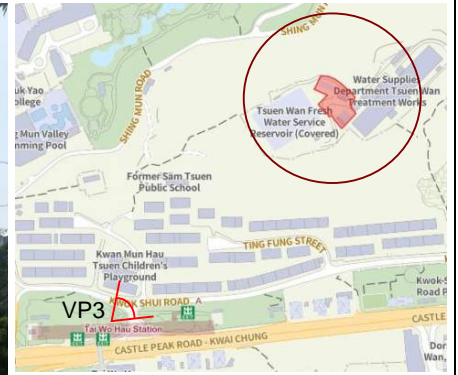

**Key Plan**



**Proposed Development**

| Figure No.                                                                          | Scale              | Figure Title                                    |
|-------------------------------------------------------------------------------------|--------------------|-------------------------------------------------|
| 39                                                                                  | -                  | Viewing Point 3 - Kwok Shui Road Park           |
|  | Date<br>March 2026 | Source<br>Photomontage for illustrative purpose |



**Existing Condtion**



Key Plan



**Proposed Development**

| Figure No.                                                                          | Scale              | Figure Title                                                               |
|-------------------------------------------------------------------------------------|--------------------|----------------------------------------------------------------------------|
| 40                                                                                  | -                  | Viewing Point 4 - Near the Entrance Gate at Shing Mun Valley Swimming Pool |
|  | Date<br>March 2026 | Source<br>Photomontage for illustrative purpose                            |

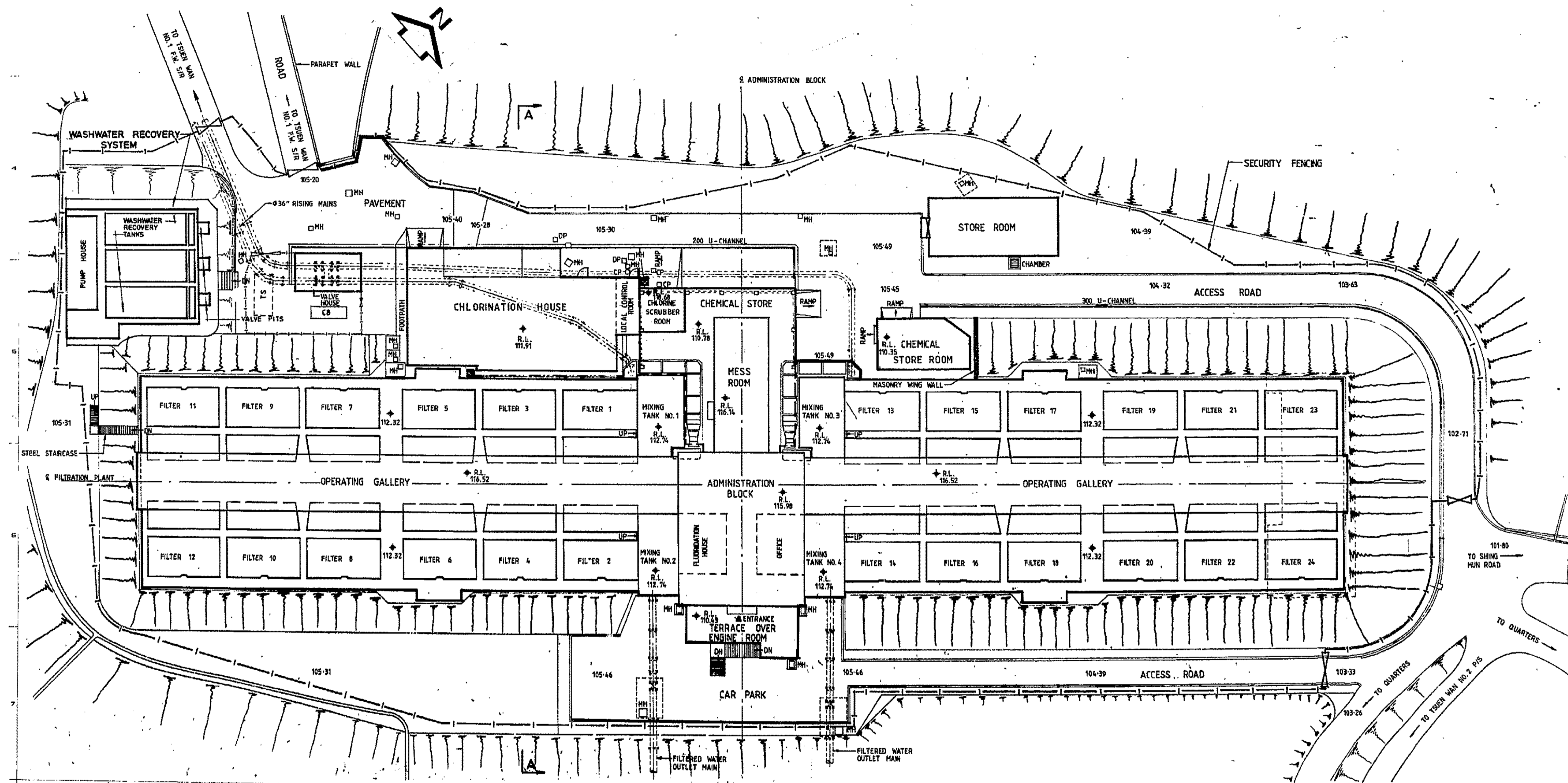

Agreement No. CE 82/2022 (WS)

Contract Title  
IN - SITU REPROVISIONING OF TSUEN WAN WATER TREATMENT WORKS - INVESTIGATION, DESIGN AND CONSTRUCTION

Drawing Title  
AS-BUILT DRAWING OF TSUEN WAN WATER TREATMENT WORKS

Drawing No. **FIGURE 41**      Revision

